

PAWEŁ JAMRÓZ*, PAWEŁ LIGEZA*, KATARZYNA SOCHA*

**DYNAMIC PROPERTIES OF HOT-WIRE ANEMOMETRIC MEASUREMENT CIRCUITS
IN THE ASPECT OF MEASUREMENTS IN MINE CONDITIONS****WŁAŚCIWOŚCI DYNAMICZNE TERMOANEMOMETRYCZNYCH UKŁADÓW POMIAROWYCH
W ASPEKTCIE POMIARÓW W WARUNKACH KOPALNIANYCH**

The use of measurement apparatus under conditions which differ significantly from those under which the apparatus was adjusted carries the risk of altering the previously determined measurement characteristics. This is of special concern in the case of apparatus which is sensitive to external measurement conditions. Advanced measurement systems are equipped with algorithms which allow the negative effect of unstable environmental conditions on their static characteristics to be compensated for. Meanwhile, the problem of altered dynamic properties of such systems is often neglected. This paper presents a model study in which the effect of variable operational conditions on dynamic response of hot-wire anemometric measurement system in the case of simulated mine flows was investigated. A mathematical model of measurement system able to compensate the negative effect of changes in flow velocity and configuration of measurement apparatus itself on its dynamic properties was developed and investigated. Based on conducted experiments, we have developed an automatic regulation algorithm enabling the transmission band of measurement apparatus to be optimized for measurement conditions prevailing in mine environment.

Keywords: measurements of flow phenomena, transmission band, limiting frequency, hot-wire anemometric measurement systems

Stosowanie aparatury pomiarowej w warunkach różnych od warunków, w których aparatura ta była adjustowana niesie ze sobą ryzyko zmian wyznaczonych wcześniej charakterystyk pomiarowych. Dotyczy to w szczególności aparatury wrażliwej na zewnętrzne czynniki pomiarowe. Zaawansowane systemy pomiarowe wyposaża się w algorytmy pozwalające na kompensację negatywnego oddziaływania zmiennych warunków środowiskowych głównie na charakterystyki statyczne. Pomija się często przy tym problem zmian właściwości dynamicznych systemów. W artykule przedstawiono modelowe badania wpływu zmiennych warunków użytkowania na odpowiedź dynamiczną termooanemometrycznego systemu pomiarowego w warunkach pomiarów symulowanych przepływów kopalnianych. Opracowano i przebadano symulacyjnie matematyczny model układu pomiarowego zdolnego do kompensacji negatywnego wpływu

* STRATA MECHANICS RESEARCH INSTITUTE OF THE POLISH ACADEMY OF SCIENCES, UL. REYMONTA 27, 30-059 KRAKÓW, POLAND

zmian prędkości przepływu oraz konfiguracji aparatury pomiarowej na jej właściwości dynamiczne. Na podstawie przeprowadzonych badań stworzono algorytm automatycznej regulacji pozwalający na optymalizację pasma przenoszenia aparatury pomiarowej w warunkach pomiarów w środowisku kopalnianym.

Słowa kluczowe: pomiary zjawisk przepływowych, pasmo przenoszenia, częstotliwość graniczna, termooanemometryczne układy pomiarowe

1. Introduction

Recently, the development of hot-wire anemometric measurement methods enabled their use not only under precisely specified laboratory conditions, but also in measurement systems which operate in significantly diversified measurement environments. An example of such application is given by measurements performed in mines, where the hot-wire anemometric methods are used to perform measurements of flow velocity profiles in mine galleries (Krawczyk et al., 2011). Among other things, such measurements enable the verification of models of mine ventilation systems with ever-increasing complexity, which for example give consideration to micro-scale phenomena related to measurements of flow turbulence phenomena occurring in near-wall layer (Ligęza et al., 2009).

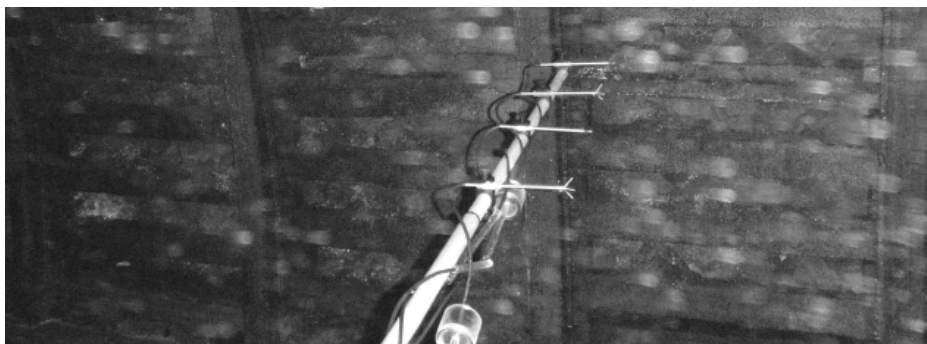

Fig. 1. Hot-wire anemometric measurements of ventilation in mine conditions

The turbulence is defined as a phenomenon which is random in time and space, and for which the formula determining its value in any given time instant is not possible to be written. Only the probability of occurrence of individual values may be determined for such signal. The analysis of turbulence as a random signal, all characteristic physical quantities of which are of variability random in time and space is based mainly on Reynolds hypothesis. According to this hypothesis, the fluid movement can be treated as a superposition of average and fluctuation movement (Elsner & Drobnik, 1995). Such an analysis is possible only on the basis of empirical results, which may be obtained with the use of hot-wire anemometers. During measurements with the use of hot-wire anemometric measurement systems, problems related to change of dynamic characteristic of hot-wire anemometric systems are often encountered. Their limiting frequency depends on configuration of electronic measurement systems and the environment in which they

are being utilized (Wattmuff, 1995; Khoo, 1998; Chew et al., 1998; Li, 2005). This comprises one of current scientific problems the solution of which will allow for measurements of random phenomena in turbulent flows to be realized using apparatuses with known metrological properties. It will especially facilitate precise and reliable analysis of measurement results.

2. Dynamic properties of hot-wire anemometric measurement systems

Dynamic response of a hot-wire anemometer is related to its voltage or current response to changing velocity and temperature of flowing medium in which the sensor is placed. In order to perform precise determination of such response it would however be necessary to generate the periodically changing velocity field. Nevertheless, with respect to the impossibility of generating such harmonically precisely specified variable fields of flow velocity, such experiments are rather impossible to be performed. Due to this reason, investigations of dynamics of hot-wire anemometric systems are performed with the use of a generator of periodically changing current signal (rectangular wave) incorporated into a hot-wire anemometric circuit. It simulates a step change of velocity generating a specified voltage response which may allows to determine the dynamic properties of the system.

For given measurement conditions and given configuration of the hot-wire anemometer, control parameters of measurement system may be adjusted in a way, such that the response of the system to rectangular signal was fifteen percent undershoot. For such settings, the time Δt is specified as the time at which the system's response reaches 3% of its maximum value. Figure 2 presents the proper response of the hot-wire anemometer obtained with the frequency test, based on which the transmission band of the whole system f_c may be assessed according to relationship 1 (Freymuth, 1977).

$$f_c = \frac{1}{1.3 \cdot \Delta t} \tag{1}$$

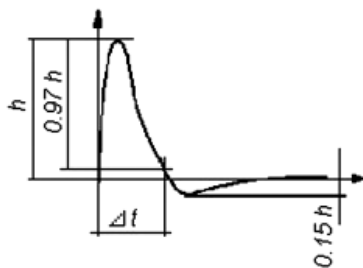

Fig. 2. Dynamic characteristic of the hot-wire anemometer

The response of the hot-wire anemometric system concerns not only the reaction of the sensor itself to changing flow conditions, but also the reaction of the entire measurement system. The

system's dynamics is related not only to physical properties of measuring wire (Jamróz, 2008, 2011) and its operational conditions, but also to characteristics of the apparatus itself, such as electronic parameters of measuring channel and the way in which the signals are brought to/from the measurement probe. Therefore it is necessary that the whole signal processing line be subject to dynamic analysis. The dynamics of the whole system depends on its individual elements. Alterations in any of them results in changes of ideal characteristics of dynamic response of the whole measurement system.

Performing measurements by means of hot-wire anemometric apparatus under operational conditions which differ significantly from laboratory ones in which the apparatus was adjusted to ensure its maximum limiting frequency, the system must be capable of adjustment in actual measurement conditions. The hot-wire anemometer capable of automatic self-regulation of its own dynamic properties depending on conditions under which it has to operate would present an optimal solution. In the next section of this study, presented is the simulation study of the effect of external measurement factors on limiting frequency of modelled hot-wire anemometric measurement system developed on the basis of the concept of system allowing for negative effects of external factors on whole system's transmission band to be compensated for.

3. A model of hot-wire anemometric measurement system

A simplified scheme of the hot-wire anemometer with potentiometric adjustment of its dynamic properties is presented in Figure 3 (Ligeża, 2007). Such a system consists of velocity measurement sensor R_S incorporated in one of the branches of resistance bridge and an operational amplifier working in the feedback loop. The sensor together with the resistor R_I and the potentiometer P_2 comprise a resistance bridge which operates as the resistance comparator system.

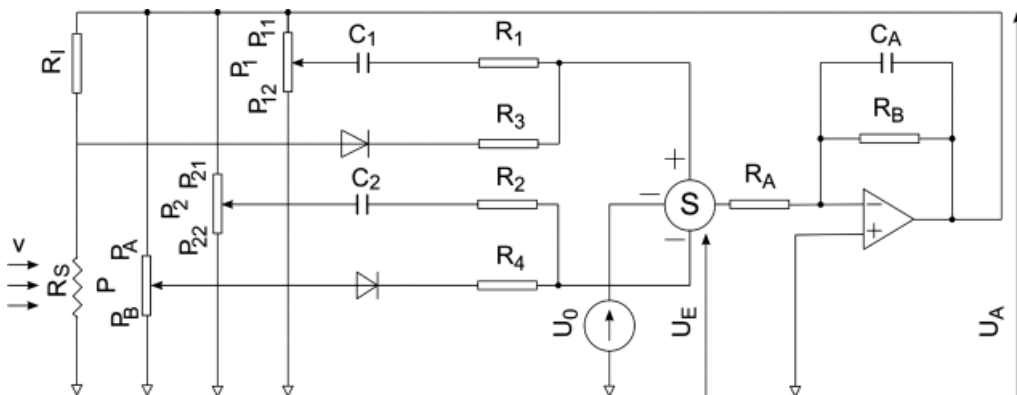

Fig. 3. The scheme of hot-wire anemometer with potentiometric adjustment of its dynamic properties

Dynamic properties of the system are adjusted through incorporating two potentiometers between the upper point and the ground point of the resistance bridge. Sliders of these potentiometers are connected to two-terminal RC network, the terminals of which are appropriately connected

to inverting and non-inverting input of measuring amplifier. According to the main concept of the system, adjustment by the potentiometer P_1 is to give the possibility to obtain the stable operation of the system following initial optimization of its transmission band. Adjustment by the potentiometer P_2 , on the other hand, should allow for final optimization of transmission band of the whole system to be obtained. Simulated step changes of the velocity are realized by means of adjusting the offset voltage of operational amplifier U_0 . For such a system, mathematical model (2) was developed, based on which the series of simulations aimed to determine the influence of external measurement conditions on system's transmission band can possibly be performed. Moreover, it also allows for the possibility of compensation of these effects to be explored.

$$\begin{aligned}
 \frac{dU_{C1}}{dt} &= \frac{U_A \left(\frac{P_{12}}{P_{11} + P_{12}} - \frac{R_S}{R + R_I} \right) - U_{C1}}{C_1 (R_1 + R_3)} \\
 \frac{dU_{C2}}{dt} &= \frac{U_A \left(\frac{P_{22}}{P_{21} + P_{22}} - \frac{P_B}{P_A + P_B} \right) - U_{C2}}{C_2 (R_2 + R_4)} \\
 \frac{dU_A}{dt} &= -\frac{1}{\tau} (U_A + k_A U_E) \\
 U_E &= \frac{U_A \left(\frac{P_{12}}{P_{11} + P_{12}} + \frac{R_1}{R_3} \frac{R}{R + R_I} \right) - U_{C1}}{\frac{R_1}{R_3} + 1} - \frac{U_A \left(\frac{P_{22}}{P_{21} + P_{22}} + \frac{R_2}{R_4} \frac{P_B}{P_A + P_B} \right) - U_{C2}}{\frac{R_2}{R_4} + 1} + U_0 \\
 \frac{dR_S}{dt} &= \frac{\frac{U_A^2 R_S}{(R_S + R_I)^2} - (A_S + B_S V^{n_S})(R_S - R_M)}{C_S} \\
 \tau &= k_A R_A C_A, \quad k_A = \frac{R_B}{R_A}
 \end{aligned} \tag{2}$$

In this model, consideration is given to dependences describing the hot-wire anemometric sensor allowing for its dynamics as well, with the sensor being described by an instantaneous value of resistance R_S and parameters A_S , B_S , n_S and c_S which specify the characteristics of the wire in the function of velocity V (Ligęza, 2001). Moreover, state variables related to instantaneous values of variable voltages U_1 and U_{C2} as well as to controller circuit U_A were specified.

4. The effect of external factors on limiting frequency of the hot-wire anemometer

Evaluation of the effect of external factors was performed based on the above presented model of hot-wire anemometer (2). Simulation testing was performed in the Matlab environment utilizing the *ode45* function enabling the calculation of differential equations. In the course of simulation, the dynamic response of measurement system in the form of instantaneous values of voltage across the wire U_{RS} was determined. The values of parameters used in simulations are presented in Tables 1, 2 and 3.

TABLE 1

Parameters of measurement probe containing the 3-um wire

R_M	T_M	α_S	A_S	B_S	c_S	n_S
Ω	K	1/K	A^2	$A^2 \sqrt{\frac{s}{m}}$	$A^2 s$	-
5	293	3.33e-3	2e-3	0.5e-3	0.5e-6	0.5

TABLE 2

Parameters of measurement probe containing the 5-um wire

R_M	T_M	α_S	A_S	B_S	c_S	n_S
Ω	K	1/K	A^2	$A^2 \sqrt{\frac{s}{m}}$	$A^2 s$	-
5	293	3.33e-3	4e-3	2e-3	4e-6	0.5

TABLE 3

Exemplary parameters of operational amplifier

RA	τA	kA
Ω	s	-
1e6	15e-3	1e6

TABLE 4

Values of coefficients of the model of hot-wire anemometer

R_I	P	P_1	P_2	C_1	C_2	R_1	R_2	R_3	R_4
Ω	Ω	Ω	Ω	nF	pF	Ω	Ω	Ω	Ω
10	10e3	10e3	10e3	47	350	1e3	100	100	100

4.1. The effect of average flow velocity on dynamic response of the hot-wire anemometer

Literature dealing with the dynamic analysis of hot-wire anemometric systems seems to point to strong dependence of limiting frequency of such systems on flow velocity. This dependence is attributable to changes of the intensity of heat exchange between the measuring wire

and flowing medium. These changes influence also the nature of the dynamic response of the measurement systems itself.

In order to emphasize the magnitude of the effect of flow velocity on limiting frequency of the system, a simulation in which the dynamic response of hot-wire anemometer was optimized for minimum velocity of 0.5 m/s was performed. As a result, the characteristic consistent with the one presented in Figure 2 was obtained. A model of sensor incorporating the measuring wire of 3 μm diameter was used in such simulation. Subsequently, increasing the flow velocity, changes in dynamic response of hot-wire anemometric measurement system were monitored. Results of the simulation are presented in Figure 4.

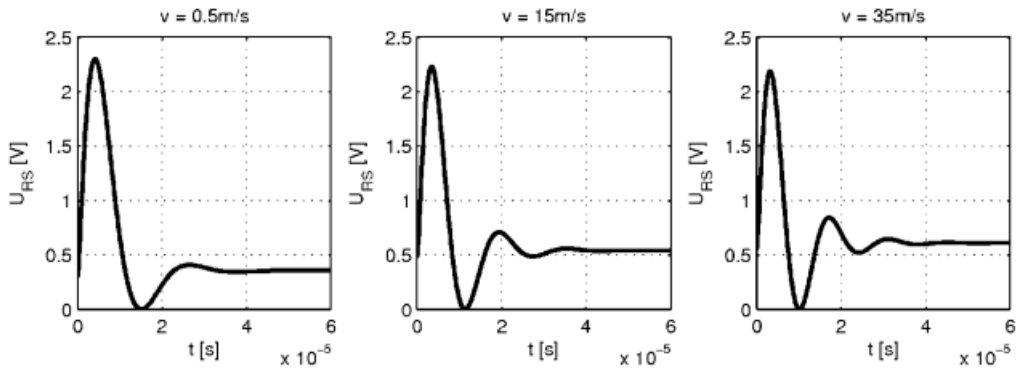

Fig. 4. The effect of average flow velocity on dynamic response of the hot-wire anemometer

Together with increasing velocity, the characteristics of dynamic response changes. The undershoot level increases and subsequent maxima occur in the signal of response, which adopts the nature of oscillatory response, leading to unstable operation of the whole measurement system.

By default, the procedure of optimization of the dynamic response of hot-wire anemometer is carried out at high velocities. Thanks to this, it is possible to avoid the risk of obtaining the unstable oscillatory operation of measurement system when measurements at lower values of velocity are performed. Figure 5 shows the results of simulation, in which the response of the system optimized with respect to time was obtained for simulated flow velocity of 35 m/s. In this case, the limiting frequency of the system was determined to be equal to 79.76 kHz. In subsequent steps of the simulation, the velocity was gradually reduced to value as low as 0.5 m/s.

As the velocity changes, the deformation of previously obtained ideally shaped characteristic of dynamic response of the system occurs, which is associated with deterioration of dynamic properties of the whole measurement system. In the case of the velocity of 15 m/s, the transmission band is maintained at the level of 62.93 kHz, nevertheless, in the case of the velocity of 0.5 m/s, this value decreases down to 43.75 kHz.

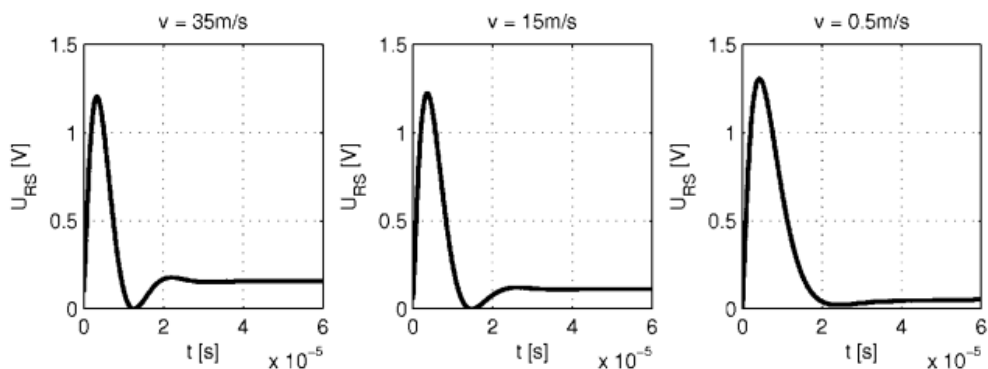

Fig. 5. The effect of average flow velocity on dynamic response of the hot-wire anemometer

4.2. The probe type and the dynamics of the hot-wire anemometer

While performing the measurements under conditions prevailing in mines, there is a high risk of damaging the hot-wire anemometric measurement probe in case of which it might become necessary to replace the sensor with another one. Each probe is characterized by its own individual parameters, such as the wire thickness or resistance. Simulative determination of the effect of changing the probe type on dynamics of the hot-wire anemometric measurement system was performed using the coefficients describing the models of 3- μm and 5- μm probes, presented in Tables 1 and 2, respectively. In the first phase, adjustment of the system was performed in a way which ensured the fastest possible time-response of the hot-wire anemometer equipped with the probe incorporating the 3- μm wire. Subsequently, the dynamic response of the system in which the 3- μm probe was replaced by a 5- μm one was recorded. Investigations were carried out at simulated flow velocity of 20 m/s. Results of the simulation are presented in Figure 6.

On the basis of results of simulation, it is possible to conclude, that the change of the probe type results in characteristics of dynamic response of the system to be deformed considerably, such

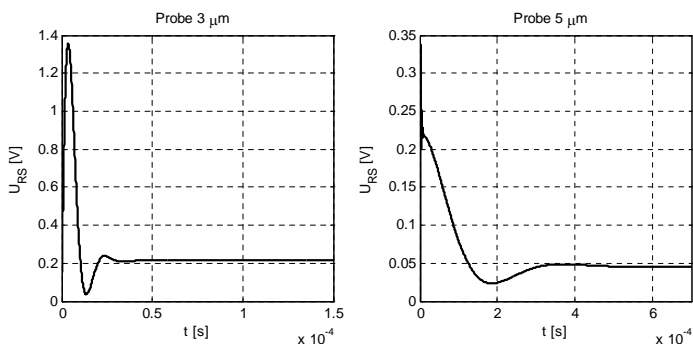

Fig. 6. The probe type and dynamic response of the hot wire anemometer

that they do not allow determining the system's dynamic properties. Conducting measurements of rapidly changing high-frequency phenomena utilizing the system with such characteristic of frequency response does not allow for accurate analysis of measurement results to be performed. In such a case, it is necessary to readjust the system in order to obtain optimal time characteristics of dynamic response of the measurement system.

In successive simulation an evaluation of the effect that replacement of measurement probe with the other one of the very same type might potentially have on dynamics of the measurement system was performed. Hot-wire anemometric probes of the same type may differ from each other in values of their resistance. It is caused by the process of their production. An initially optimized dynamic response of the system equipped with the wire of $3\ \mu\text{m}$ in diameter and resistance of $5\ \Omega$ for $T_M = 293\ \text{K}$ was analyzed in the simulation. In subsequent phases of investigations, the system's response given the changing resistance of the sensor was recorded. Results of the simulation are presented in Figure 7.

Results of conducted simulation point to significant effect of measurement sensor's resistance on obtained transmission band of the whole measurement system. Increase in resistance by $0.3\ \Omega$ above the initial value in the same temperature results in observable changes in characteristics of

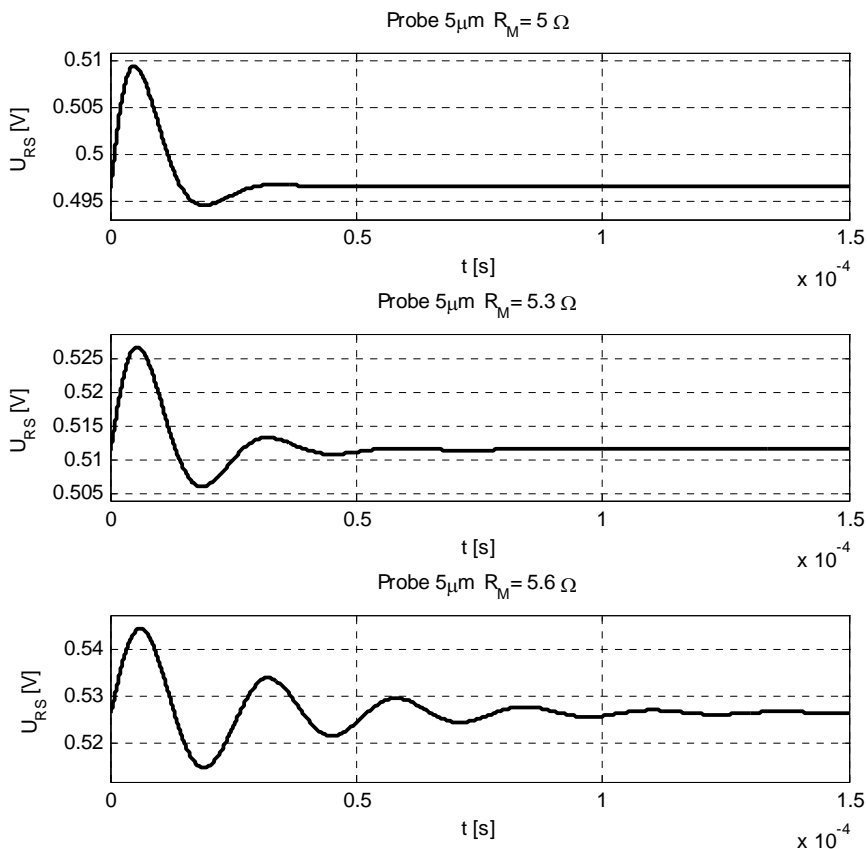

Fig. 7. The sensor's resistance and dynamic response of the hot wire anemometer

dynamic response of the measurement system. These changes require fine adjustment of system's response to obtain optimal characteristics. Higher values of resistance lead to unstable operation of the whole system, which may end up in burn-through of the measurement sensor.

5. Adjustment of dynamic properties

In the series of simulations conducted in order to explore the effects of external measurement factors on transmission band of the hot-wire anemometric measurement systems, their considerable effect on shaping of dynamic properties of measurement apparatus was demonstrated. Measurements under conditions prevailing in mines with the use of hot-wire anemometers require compensation methods allowing for negative effects of various factors not only on static characteristics of such devices but also on their dynamic characteristics, to be eliminated. Such compensation is provided by the system presented in Figure 2. In this system, the adjustment takes place by adopting appropriate settings of P_1 and P_2 potentiometers such that they would ensure that fifteen per cent undershoot in dynamic response of the system is obtained – Figure 2.

The value of resistance of adjusting potentiometers, for which the system under investigation is characterized by stable yet slow dynamic response, has already been determined on the basis of results of performed model testing (Jamróz et al., 2010). Such response is being recorded for the lowest value of resistance P_1 and maximum value of resistance P_2 . These values were used as starting points for adjustment algorithms.

During simulation it was shown, that a series of pairs of settings of potentiometers P_{11} and P_{21} exists, for which the dynamic response of the system is consistent with optimum characteristics presented in Figure 2. Results of exemplary simulation illustrating the number of such pairs are presented in Figure 8, in which the black colour designates the areas in which the dynamic

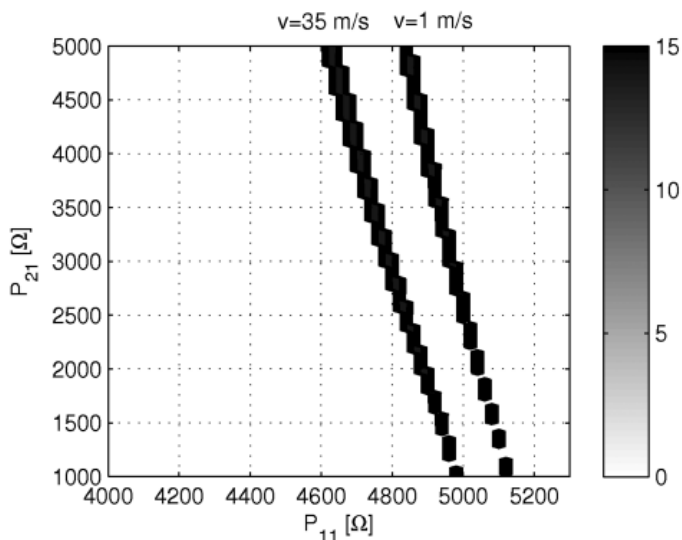

Fig. 8. Area of adjustment for flow velocities of 1 and 35 m/s

response of the system is in line with the optimum characteristics. Simulations were carried out using the model of the 3- μm probe and for the velocity of 1 and 35 m/s.

Areas of adjustment which ensure the obtention of optimum characteristics of dynamic response of the system change depending on changes of actual values of external measurement factors as well as on electronic configuration of the measurement system itself.

In the next part of the study the value of limiting frequency for the above mentioned simulation conditions was determined. Obtained results are presented in Figure 9.

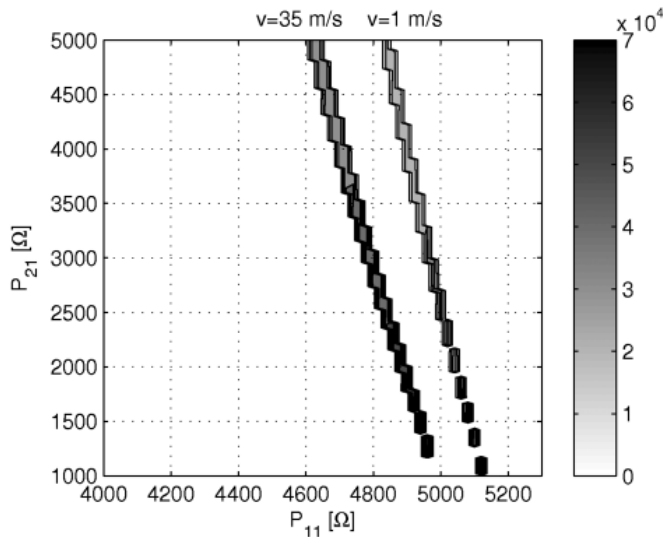

Fig. 9. Limiting frequency of the system for flow velocities of 1 and 35 m/s

Performed simulation indicate, that the highest values of limiting frequency are obtained for those pairs of resistance of adjusting potentiometers in the case of which the values of resistances P_{11} and P_{21} are the highest and the lowest possible, respectively. These are the limiting values of resistance the exceeding of which results in unstable operation of the whole apparatus.

6. The algorithm of automatic optimization of transmission band

Employment of digitally adjusted potentiometers allows for algorithm of automatic optimization to be performed. Development of algorithm of automatic adjustment is based on movements along the adjustment characteristic within areas, in which the obtained dynamic response of analyzed object is characterized by properties typical for model response of a hot-wire anemometric measurement system. The process of adjustment takes place until the optimum transmission band of measurement system is obtained. Such an algorithm allows for the widest possible transmission

band to be obtained, nevertheless, in order to acquire the desirable effect, prolonged realization of such control process is required. Reduction of time of realization may be achieved by dividing the adjustment process into initial and final optimization steps.

6.1. Initial optimization

The first phase of transmission band optimization is based on adjustment realized in several iterations, allowing for initially optimized transmission band of measurement system to be obtained in relatively short time. The principle of this method is presented in the form of an example of simulation performed for 3- μm sensor placed in the flow the velocity of which is equal to 1 m/s.

The algorithm of initial optimization was developed on the basis of observation of the process of adjustment of the model and actual measurement system. It is based on adjustment starting from settings which guarantee stable yet slow dynamic response of the system (minimum and maximum values of P_{11} and P_{21} resistances, respectively) – see Figure 10.

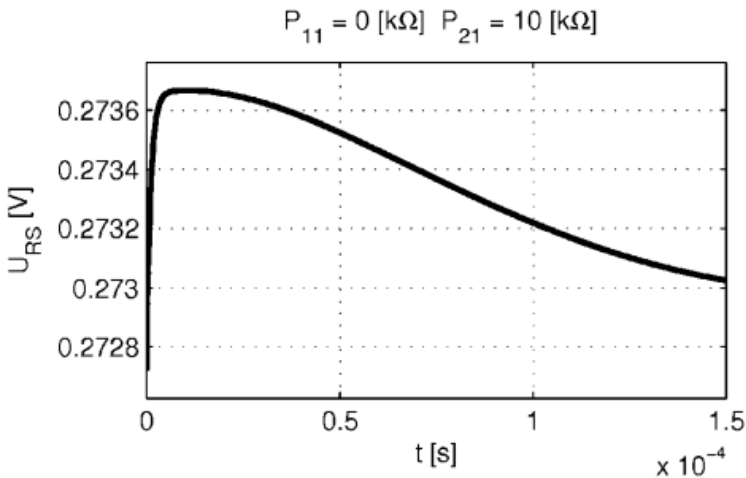

Fig. 10. Dynamic response of the model of hot-wire anemometer in the case of starting settings of adjusting potentiometers

In the first phase of optimization, the value of resistance P_{11} is reduced to the level which allows for dynamic response of the measurement system characterized by occurrence of successive periods of over-regulation (with three local maximums) to be obtained – see Figure 11. During observations of the process of adjustment of model and actual measurement systems performed for different configurations and under various measurement conditions we noticed, that obtainment of such characteristic, with the starting value of resistance P_{21} maintained at fixed level at the same time, allows in the next step of adjustment process for the dynamic response of the system to be brought to a form consistent with the one showed in Figure 2.

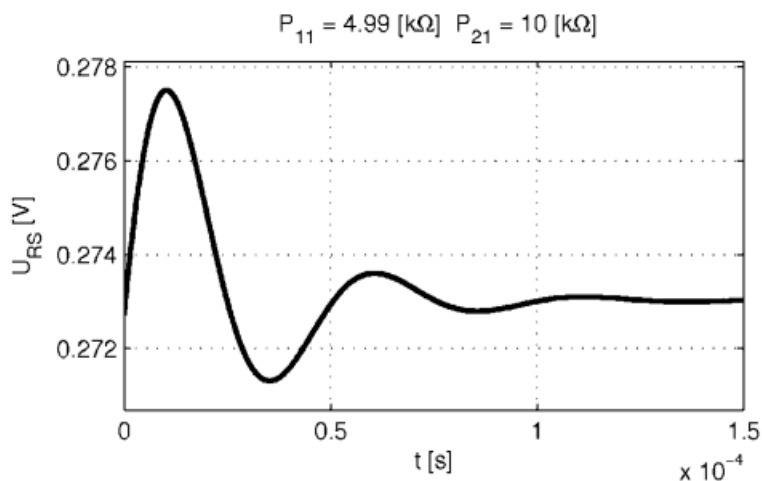

Fig. 11. Dynamic response of the model of hot-wire anemometer after the first phase of the algorithm of initial optimization of transmission band

The final step of the adjustment procedure consists in the reduction of the value of resistance P_{21} to the level, in which the obtained characteristic of dynamic response of the system is as close to the model characteristic as possible. In the analyzed example, employment of automatic algorithm of initial optimization of transmission band allowed for obtainment of dynamic response

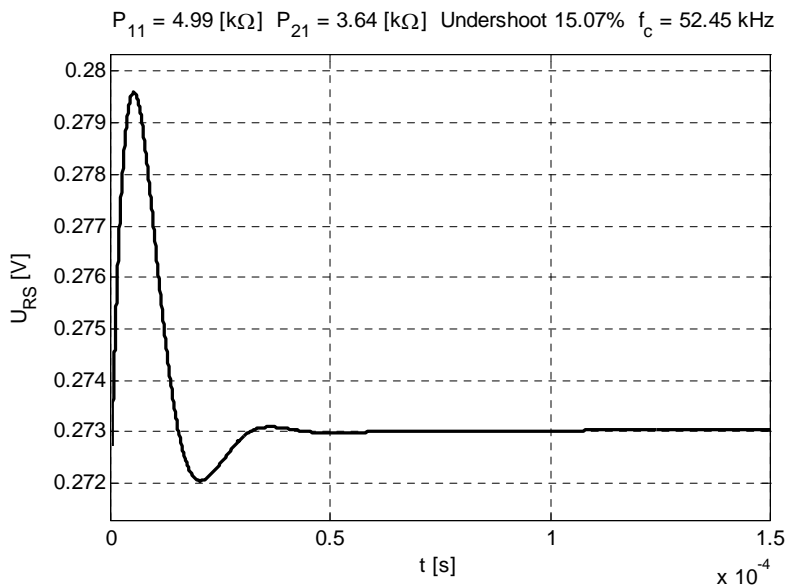

Fig. 12. Dynamic response of the model of hot-wire anemometer following the initial optimization of transmission band

of the system with limiting frequency equal to 52.45 kHz. Although the obtained transmission band is not optimal for sensors incorporating 3- μm wires, it may still be considered sufficient for the majority of measurement situations.

Presented adjustment procedure provides fast optimization of the system with respect to its dynamic properties. Manual optimization process however shows that even wider transmission band can possibly be obtained. It requires an additional adjustment of the system.

6.2. Final optimization

Main assumption underlying the procedure of final optimization is to obtain the widest transmission band possible for different configurations of the system and under various measurement conditions. Optimization algorithm starts with the values of resistances P_{11} and P_{21} obtained as a result of the process of initial optimization. In the first step of final optimization, the resistance P_{11} becomes increased by a preset value Δp_1 . Subsequently, on the basis of performed measurement of dynamic response of the system, the value of over-regulation is checked. If the value is below 14.8%, the value Δp_2 is reduced by a half and the resistance P_{21} becomes increased by a new value of Δp_2 . If obtained value of undershoot exceeds 15.2%, the resistance P_{21} becomes reduced by the value of Δp_2 . Following each such change of the value of resistance, a measurement of dynamic response of the system is performed. The process of such adjustment takes place until the response with undershoot falling within the range of 14.8÷15.2% is obtained.

Acquirement of optimum transmission band is connected with the achievement of ideal characteristics of dynamic response showing only one maximum. Appearance of additional maximum signifies that the signal is over-regulated, therefore the level of this additional maximum in relation to the level of the steady signal may be considered as a criterion of final adjustment. If this criterion is fulfilled, the value of the resistance P_1 is increased by Δp_1 and the variable Δp_2 is assigned its initial value. The algorithm of the final optimization ends, if it becomes impossible for subsequent value of P_{11} increased by the step Δp_1 to find a matching value of the resistance P_{21} which would ensure the decrease of the magnitude of the additional maximum below the preset limit. It is a criterion, for which the obtained course of dynamic response of the hot-wire anemometer is considered optimal.

6.3. Evaluation of algorithm efficacy

For algorithms described above the simulation studies allowing for evaluation of their efficacy in the case of adjustment in flows of different velocities were performed. Results for the 3- μm sensor are presented in Figure 13. As a result of initial optimization procedure, the limiting frequencies ranging from 52.45 kHz for velocity of 1 m/s to 82.83 kHz for 35 m/s were obtained. Conducting the procedure of final optimization of the transmission band leads to a significant improvement of obtained dynamics of the system, especially in the case of low flow velocities. In the case of flow velocity of 1 m/s, the limiting frequency of the system was increased by 13.99 kHz. In the case of higher velocities, achieved increase in limiting frequency was smaller. The value of limiting frequency for velocity of 35 m/s was increased by only 4.02 kHz.

Analogous simulation study was performed also for a measurement sensor incorporating the wire of 5 μm in diameter, for which the limiting frequency was determined in a wide range of flow velocities. Alike the case of wire of 3 μm in diameter, the highest efficacy of the algorithm

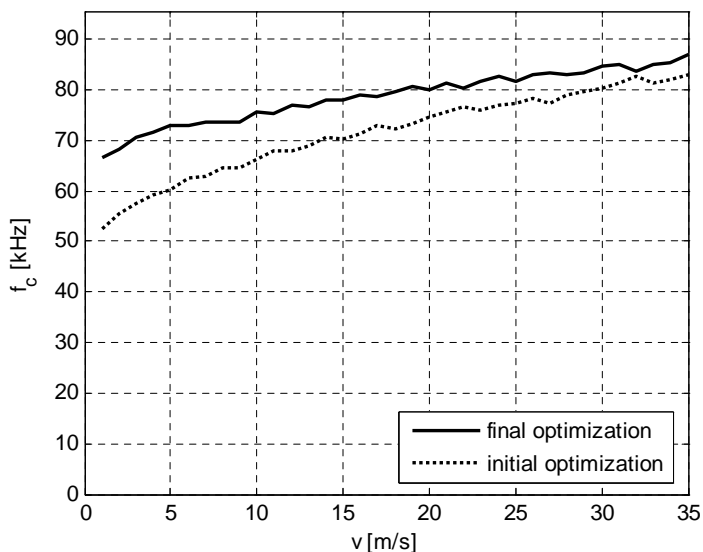

Fig. 13. Results of the initial and final optimization of the transmission band – 3- μ m probe

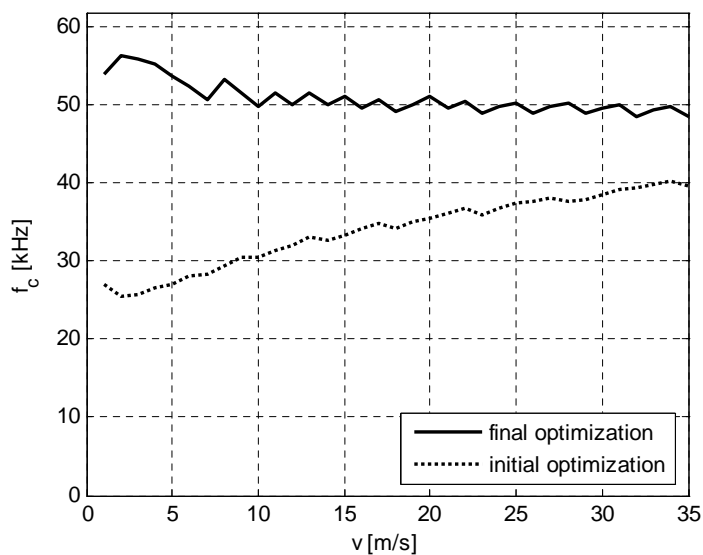

Fig. 14. Results of the initial and final optimization of the transmission band – 5- μ m probe

of final optimization of transmission band was revealed for the velocity of 10 m/s. In the case of low velocities, employment of the second phase of adjustment resulted in the limiting frequency of the system being increases by 20.75 kHz at most.

7. Conclusion

Measurement conditions other than those under which the measurement instruments were adjusted may result in their altered processing characteristics. This especially concerns their static characteristics. The need for performing the observations and analyses of high-frequency flow phenomena is connected with the question on dynamics of such systems as well as the question on the effect of external measurement factors on transmission band of measurement systems. The model testing of hot-wire anemometric measurement system presented hereby point to considerable dependence of dynamic response of such instruments on their configuration and/or environmental factors. This became the grounds for the development of conception of a system capable of performing the automatic procedures of self-adjustment in actual measurement conditions. Obtained results of simulation studies confirm the capability of hereby presented system to fulfil such goal and present the basis for realization of actual measurement system based on presented idea.

References

- Chew Y.T., Khoo B.C., Lim C.P., Teo C.J., 1998. *Dynamic response of hot-wire anemometer. Part II: A flush mounted hot-wire and hot-film probes for wall shear stress measurements*. Measurement Science and Technology, 9, no. 5 p. 764-778.
- Elsner J.W., Drobnik S., 1995. *Metrologia turbulencji przepływów*. Vol. 18 of the series Maszyny Przepływowe. The Ossolinski National Institute.
- Freymuth P., 1977. *Frequency response and electronic testing for constant-temperature hot-wire anemometers*. Journal of Physics E.: Scientific Instruments; vol. 10: p. 705-710.
- Jamróz P., 2008. *Wielomianowe modele współczynnika dynamiki czujników temperatury w warunkach zmiennych przepływów*. Przegląd Elektrotechniczny, 9/2008.
- Jamróz P., Ligęza P., Socha K., 2010. *Zaawansowane narzędzia metrologiczne w pomiarach wybranych parametrów środowiska. Optymalizowany dynamicznie termoanemometryczny system pomiarowy*. Prace Instytutu Mechaniki Górotworu PAN, Vol. 12, No. 1-4.
- Jamróz P., 2011. *Relationship Between Dynamic Coefficients of Two Temperature Sensors Under Nonstationary Flow Conditions*. IEEE Sensors Journal, Vol. 11, Issue 2, pp. 335-340.
- Khoo B.C., Chew Y.T., Lim C.P., Teo C.J., 1998. *Dynamic response of hot-wire anemometer, Part I: A marginally-elevated hot-wire probe for near-wall velocity measurements*. Measurement Science and Technology, 9, no. 5 p. 751-763.
- Krawczyk J., Ligęza P., Poleszczyk E., Skotniczny P., 2011. *Advanced hot-wire anemometric measurement systems in investigation of the air flow velocity fields in mine headings*. Arch. Min. Sci., Vol. 56, No 4, p. 683-701.
- Li D.J., 2005. *The effect of electronic components on the cut-off frequency of the hot-wire system*. Measurement Science and Technology, vol. 16, No 3: pp. 766-774.
- Ligęza P., 2001. *Układy termoanemometryczne-struktura, modelowanie, przyrządy i systemy pomiarowe*. vol. 98 from the series „Rozprawy Monografie”. AGH Uczelniane Wydawnictwa Naukowo-Dydaktyczne, Cracow.
- Ligęza P., 2007a. *Układ anemometru stalotemperaturowego z regulacją właściwości dynamicznych*. Polska Akademia Nauk Instytut Mechaniki Górotworu, Kraków. Polska. Opis patentowy. 382135. Zgłoszono 04.04.2007.
- Ligęza P., Poleszczyk E., Skotniczny P., 2009. *Hot-wire anemometric measurement systems in mining applications*. Arch. Min. Sci., Monograph number 6, pp. 1-92.
- Watmuff J.H., 1995. *Investigation of the constant-temperature hot-wire anemometer*. Experimental Thermal and Fluid Science, Vol. 11, no. 2: pp. 117-134.