

An Ultra-Wideband System for Vehicle Positioning

Jerzy Kolakowski, Jacek Cichocki, Piotr Makal, and Ryszard Michnowski

Abstract—Systems supporting traffic safety require precise information on a vehicle position. The paper contains a proposal for a vehicle localization system based on ultra-wideband (UWB) technology. The system allows for vehicle positioning with sub-meter accuracy. The paper presents a system concept and an algorithm used for position calculation. The algorithm consists in selection of a system configuration in order to decrease the positioning uncertainty. The system concept was verified with a developed system demonstrator. The paper contains a description of the devices comprising the system. Exemplary results of outdoor demonstrator tests are included and discussed. The tests confirmed efficiency and attractiveness of the proposed solution.

Keywords—UWB, vehicle positioning, positioning systems, TDOA.

I. INTRODUCTION

INTEREST in vehicle location systems began in the 70s of the previous century. The motivation was a more efficient use of vehicle resources or providing driver safety. First solutions, based on maritime navigation systems e.g. LORAN or Decca Navigator System, offered a location uncertainty in order of a few tens of meters. Nowadays GPS navigation units are practically standard vehicle equipment.

Recently vehicle positioning systems start to play a crucial role for traffic safety. Supporting lane change maneuvers, overtaking, or helping to keep a safe distance are a few examples of such applications [22].

An analysis of applications and needs performed within the SAFESPOT project [16], [22] resulted in the specifications of requirements concerning vehicle location system. It was found that in the most requiring intersection and tunnel scenarios the lateral positioning uncertainty should be lower than 0.5 m and the longitudinal higher than 1 m. A delay in the position delivery, measured as the interval between the time of measurement and the time when information on the position is available, should not exceed 150 ms. The positioning system shall provide the position estimation with an update rate of 20 Hz.

Commonly used GNSS (Global Navigation Satellite System) technologies are not able to provide reliable results in specific, hard conditions (e.g. city centers, tunnels, underground parking areas) – signal discontinuities and multipath propagation seriously deteriorate the positioning accuracy or even disable position determination. In such cases,

This work was supported by the European Union Commission under Contract FP6-IST-4-026963 of the SAFESPOT project.

J. Kolakowski, J. Cichocki, P. Makal, and R. Michnowski are with Institute of Radioelectronics, Warsaw University of Technology, Nowowiejska 15/19, 00-665 Warsaw, Poland (e-mail: {j.kolakowski; j.cichocki; p.makal; r.michnowski}@ire.pw.edu.pl).

GPS based systems should be supported by other solutions. Positioning information delivered by different systems and sensors can be combined with data fusion algorithms. A survey concerning this approach can be found in [17], examples of implementation in [15].

Ultra-wideband (UWB) technology seems to be especially relevant for positioning purposes. Due to the very wide signal bandwidth, it offers great positioning accuracy and excellent immunity to interference and multipath propagation [14]. There are a few examples of commercially available UWB localization systems for indoor person and asset tracking [23], [24]. They offer a positioning uncertainty less than several centimeters. Despite legal regulations [1], [2], [4] which limit the accessible bandwidth and the power of UWB emissions, the range of system operation can reach even a few hundred meters.

Application of UWB technology for vehicle positioning was rarely analyzed in literature. A mixed UWB – GPS system was proposed in [5]. A concept of an UWB system based on pulse level measurements can be found in [13]. The simulation of a system based on the time of pulse arrival determination is presented in [21].

We propose a novel approach to the ultra-wideband vehicle positioning. It is based on unilateral system architecture, which is not used in commercial systems, but in our opinion is better for vehicular applications. The next section of the paper contains a comparison of both approaches. Our proposal was verified using the system demonstrator developed within the SAFESPOT project [22].

The paper is organized as follows. Section II addresses the positioning system architecture. It contains a discussion of unilateral and multilateral approaches to system design. Section III presents the concept of the system. Section IV highlights the algorithm used for the position determination. In Section V the demonstrator of an ultra-wideband positioning system is presented. The section contains a description of the transmitter and the receiver. An experimental verification of the demonstrator is shown in Section VI. Section VII concludes the paper.

II. POSITIONING SYSTEM ARCHITECTURE

The general positioning system architecture is presented in Fig. 1. The system contains a set of fixed nodes $N_1 \dots N_n$, whose positions are known, and mobile nodes (N_x) which are to be located. In a multilateral system, N_x location is calculated from measurements taken by fixed nodes. By contrast, in a unilateral version N_x nodes receive signals from fixed nodes and calculate their own positions.

The choice of a multilateral or unilateral architecture does not preclude any positioning techniques traditionally used in

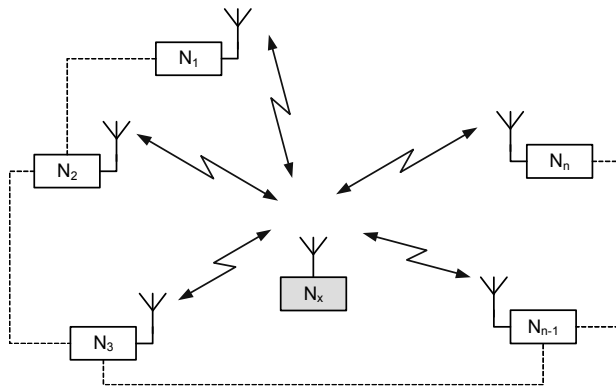

Fig. 1. General positioning system architecture.

localization systems. The full exploitation of UWB advantages inclines to positioning methods based on measurements of TOAs (Time of Arrival) or TDOAs (Time Difference of Arrival). However, the measurement of TDOAs does not require bi-directional UWB radio links between fixed and mobile nodes and, thus, the design of the system radio interface is simpler. The discussion of the implementation of multilateral and unilateral architectures in vehicular positioning systems presented below assumes the use of the TDOA based positioning method.

Commercially available UWB systems and UWB system proposals described in literature are based on the multilateral approach. Fixed nodes are responsible for TDOA measurements, mobile nodes are the sources of UWB pulses. The implementation of the multilateral solution can raise some problems, especially if the number of mobile nodes becomes large. An access scheme assuring that mobile nodes do not transmit at the same time becomes necessary. Its implementation requires additional communication between the mobile and fixed nodes which increases the system complexity. Such an approach is justified in case when the rate of positioning is not of a prime importance.

The multilateral architecture offers several advantages. The mobile node design is simple and its energy requirements are very low. Moreover, the cost of the mobile node is lower than the cost of the fixed one.

The paper deals with an approach based on the unilateral architecture. System infrastructure is based on a network of synchronized, ultra-wideband transmitters; the mobile nodes are responsible for the reception of UWB signals, TDOA measurements, and position calculations. Due to the limitation of node functions to reception or transmission, the design of the devices can be simplified. The lack of additional transmitters improves the overall onboard electromagnetic compatibility (there are usually sensitive receivers in use - e.g. GPS). The unilateral system provides an excellent scalability; the system architecture does not put any limits on the number of localized objects. There is no need to implement a multiple access scheme, so the rate of position update can be high, even in heavy traffic conditions.

An increased mobile node complexity (and its cost) is the main system disadvantage. The larger energy requirements seem to be not significant in case of today's vehicles.

Table 1 summarizes the main characteristics of multilateral and unilateral system architectures relevant to their

TABLE I
COMPARISON OF MULTILATERAL AND UNILATERAL ARCHITECTURES
CHARACTERISTICS IMPORTANT FOR VEHICULAR APPLICATIONS

System feature	System architecture	
	multilateral	unilateral
TDOA measurements and position calculation	infrastructure (fixed nodes)	onboard
Scalability	increasing number of mobile nodes decrease system speed	excellent
Access control	required	not required
Speed of operation	depends on the number of mobile nodes	dependent on the number of fixed nodes
Infrastructure	includes complex receivers, equipped with measurement circuits	a network of transmitters
Influence on the onboard electromagnetic compatibility	requires attention (transmitter onboard)	very good (only receiver onboard)
Synchronization	synchronized receivers	synchronized transmitters
Onboard energy requirements	lower	higher
Onboard equipment complexity	lower	higher
Overall system complexity	bigger	smaller

implementation in a vehicular environment.

III. SYSTEM CONCEPT AND OPERATION

The general architecture of the proposed system is in accordance with the concept depicted in Fig. 1. The system consists of:

- 1) a set of TXUs (transmitter units) mounted on road infrastructure objects,
- 2) the RXUs (receiver units) mounted in vehicles.

The transmission pattern specific to the system containing N transmitter units is presented in Fig. 2. The transmissions are repeated with T_{CYCLE} period. During one period all TXUs emit their packets one after another with the predefined delay (T_{DEL}) between the transmissions.

The structure of the transmitted packets is shown in Fig. 3. The preamble field contains a sequence of pulses repeated with T_{PRMB} period. The field is necessary for the proper determination of pulse levels and, thus, makes an easy implementation of automatic gain control circuitry in the

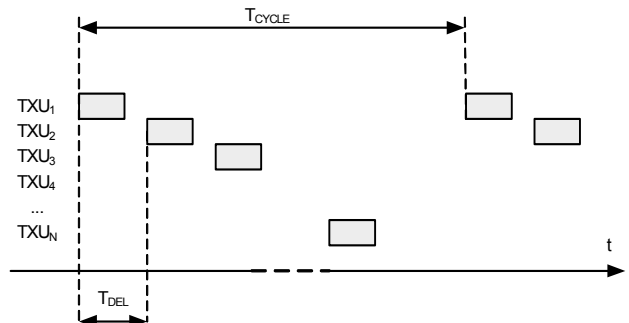

Fig. 2. Transmission pattern in a system including N TXUs.

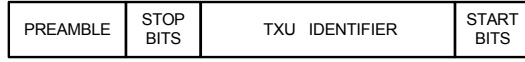

Fig. 3. Packet content.

receiver possible. The TX IDENTIFIER field contains a unique identifier corresponding to the sending transmitter. Start and stop bits are used for triggering and terminating time interval measurement in the receiver.

The measurement of intervals between consecutive packets is illustrated in Fig. 4.

The time delays measured between the decoded stop and start sequences can be used for a time difference of arrival (TDOA) evaluation. The measured value is a sum of the following components:

$$TD_{N,N+1} = TDOA_{N,N+1} + T_{SEQ} + T_{DEL} + T_{TRIG} \quad (1)$$

where

$TDOA_{N,N+1}$ - time difference of arrival of signals from TX_N and TX_{N+1} ,

T_{SEQ} - a time interval between start and stop sequences in the packet,

T_{DEL} - an intentional delay introduced by transmitters,

T_{TRIG} - triggering signal delays specific to each transmitter.

The sum of triggering signal delays ($T_{TRIG} + T_{DEL}$) can be evaluated during the system calibration process and subtracted from the measurement results.

The calculation of the position requires data describing the system implementation, in particular the coordinates of the transmitters, the transmission pattern, and calibration data. The data should be transferred to the receiver before the vehicle enters the system operation area.

IV. POSITIONING ALGORITHM

A. Introduction

TDOA based algorithms for the determination of the object position are being developed for a few decades, so the number of publications that address the explicit calculation of the source location is substantial. Examples of problem solutions can be found in [3], [6], [18], [20] and references cited therein.

In the developed system demonstrator we have used a direct analytical solution to the problem, because it is simple and requires relatively low computational effort. Generally, at least four transmitters are required for the determination of a position in 3D space.

The distance between the transmitter located at (x_i, y_i, z_i) and the receiver located at (x, y, z) can be expressed as:

$$\sqrt{(x - x_i)^2 + (y - y_i)^2 + (z - z_i)^2} = c(t_i - t_0), \quad (2)$$

$$i = 1 \dots 4$$

where

c – speed of light,

t_0 – transmission start time,

t_i – time when the signal reached receiver's input.

The object coordinates can be found by solving the system of four equations (derivation can be found in e.g. [10]).

Unfortunately, we obtain two z-coordinate values. In case of vehicle localization, the approximate height of the UWB antenna is known, so it is easy to eliminate an erroneous solution. When the system operation area is a flat surface, information on the antenna height (z-coordinate) can be used for a simplification of the solution. The coordinates can be calculated using the following equations:

$$x = \frac{z(\gamma_{y2}\gamma_{z1} - \gamma_{y1}\gamma_{z2}) - \gamma_{y2}\beta_1 + \gamma_{y1}\beta_2}{\gamma_{x2}\gamma_{y1} - \gamma_{y2}\gamma_{x1}} \quad (3)$$

$$y = \frac{z(\gamma_{x2}\gamma_{z1} - \gamma_{x1}\gamma_{z2}) - \gamma_{x2}\beta_1 + \gamma_{x1}\beta_2}{\gamma_{y2}\gamma_{x1} - \gamma_{x2}\gamma_{y1}} \quad (4)$$

where

$$\beta_1 = \frac{c^2}{2} \Delta t_{31} \Delta t_{23} \Delta t_{12} - \frac{\alpha_{23} \Delta t_{12}}{2} + \frac{\alpha_{12} \Delta t_{23}}{2},$$

$$\beta_2 = \frac{c^2}{2} \Delta t_{42} \Delta t_{34} \Delta t_{23} - \frac{\alpha_{34} \Delta t_{23}}{2} + \frac{\alpha_{23} \Delta t_{34}}{2},$$

$$\gamma_{a1} = \Delta t_{12} \Delta a_{23} - \Delta t_{23} \Delta a_{12}, \text{ where } a = x, y, z,$$

$$\gamma_{a2} = \Delta t_{23} \Delta a_{34} - \Delta t_{34} \Delta a_{23}, \text{ where } a = x, y, z,$$

$$\Delta a_{ij} = a_i - a_j, \text{ where } a = x, y, z, t,$$

$$a_{ij} = x_i^2 - x_j^2 + y_i^2 - y_j^2 + z_i^2 - z_j^2,$$

$$\Delta t_{ij} = TDOA_{ij}.$$

Unfortunately, there are singularities in solutions (3) and (4); for some combination of TDOA values we can obtain unreliable results. The method for their elimination is described in section IV.C.

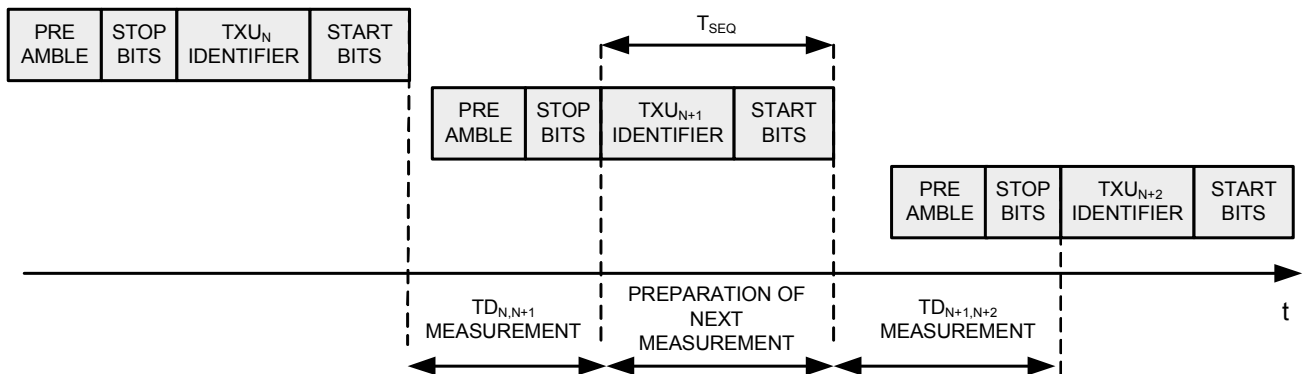

Fig. 4. Time interval measurement method illustration.

B. Input Data Uncertainty

The positioning algorithm should minimize the impact of input data uncertainty. There are two main contributors to the overall positioning uncertainty: the uncertainty of TDOA determination and the uncertainty of transmitter position measurements. The TDOA uncertainty depends on the jitter of emitted pulses, receiver noise, interference originating from the propagation channel, and the uncertainty of the calibration results. The TDOA measurement uncertainty changes with the signal-to-noise ratio and, thus, with the receiver location.

The positioning algorithm performance depends not only on the quality of input data but also on the transmitter configuration. The problem of finding an optimal configuration was reported in several publications e.g. [9], [11]. Similar results were obtained for different positioning algorithms and different cost functions. Reaching minimum positioning uncertainty for a fixed receiver position requires the distribution of the transmitters on a sphere. If the position is calculated in a four transmitter configuration, the transmitters should be placed in the corners of a tetrahedron.

In real implementations, the problem of transmitter configuration is more complex because the receiver position is a subject to change. The shape of the area and places where the transmitters can be mounted are usually specified. Moreover, in systems based on time of arrival measurements, the transmitter configuration should provide line of sight propagation of transmitted signals.

Although theoretical analyses provide some general rules how to place the system nodes, there is a need for algorithms that optimize the use of the specified system configuration.

C. Algorithm

The proposed algorithm is focused on minimizing the position uncertainty. It takes advantages of the over-determined architecture and consists of a selection of the transmitter configuration for the position calculation.

Before the algorithm can be used, data controlling selection should be prepared. An algorithm for data preparation for a grid consisting of N_G points is as follows:

For $n=1..N_G$

- 1) Select a reference point
- 2) For $i=1:N_C$
 - a) Select a configuration of four transmitters
 - b) For $k=1..N_P$
 - i) Calculate TDOAs
 - ii) Modify TDOAs and transmitter coordinates with generated error terms
 - iii) Evaluate the position and calculate the total position error
 - c) Calculate the positioning error standard deviation
- 3) Select and store the transmitter configuration providing the lowest positioning uncertainty

N_P is a number of calculations performed at each reference point, N_C – a number of transmitter configurations i.e. number of four-transmitter subsets of a set of N_T transmitters $N_C = \binom{N_T}{4}$.

The error terms used for TDOA and transmitter coordinates modification correspond to the TDOA measurement uncertainty and the uncertainty of the transmitter position determination. In the proposed unilateral system, the receiver

measures the TDOAs between signals coming from successive transmitters. If the chosen system configuration requires the use of TDOAs that were not directly measured (eg. TDOA between first and third transmitter), the TDOA uncertainty should be appropriately increased (multiplied by a N where N – is a number of summed TDOAs).

The total positioning error denotes a length of a vector connecting reference and calculated points. The standard deviation of N_P total positioning errors was used as a measure of the positioning uncertainty corresponding to the reference point.

The presented approach assumes that systematic TDOA measurement errors have been removed, so the location estimators are unbiased. In a real system, the bias depends on the systematic errors introduced by the receiver.

The described data preparation process results in a set of transmitter configurations providing a minimum positioning uncertainty for each of the reference points. The obtained data can be used for a dynamic selection of the transmitter configuration in accordance with the following algorithm:

- 1) Evaluate the initial transmitter configuration
- 2) Measure TDOAs
- 3) Calculate the position using the TDOAs corresponding to the selected configuration
- 4) Choose the reference point closest to the position and select the best transmitter configuration
- 5) Go to step 2

The most important step is the determination of the initial configuration. In the proposed solution positions for all combinations of transmitters are calculated and doubtful results are rejected with the use of Chauvenet's criterion [19]. Finally, an average position is evaluated and the configuration providing result closest to average is chosen.

D. Simulations

The results of simulations, presented in this section, illustrate the positioning algorithm efficiency. The parameters of an area chosen for simulation as well as the distribution of the transmitters is close to the configuration used during a system demonstrator test session described in section VI. The simulation parameters are included in Table 2. The values of uncertainties taken for simulations are based on properties of the equipment used for experiments. The value of the TDOA measurement uncertainty is based on the results of tests of the receiver used in the demonstrator (see [7]).

TABLE II
SIMULATION PARAMETERS

Reference points location	a uniform grid (0.5 m x 0.5 m) at height 1.8 m.		
Uncertainty of transmitter coordinates measurement (1σ)	0.03 m (normal distribution)		
Uncertainty of TDOA measurement (1σ)	200 ps (normal distribution)		
Numbers of simulations per reference point	1000		
TXU coordinates	x [m]	y [m]	z [m]
TXU1	0	0	2
TXU2	16	11	2
TXU3	24	0	2
TXU4	15	1	2
TXU5	10	-15	2

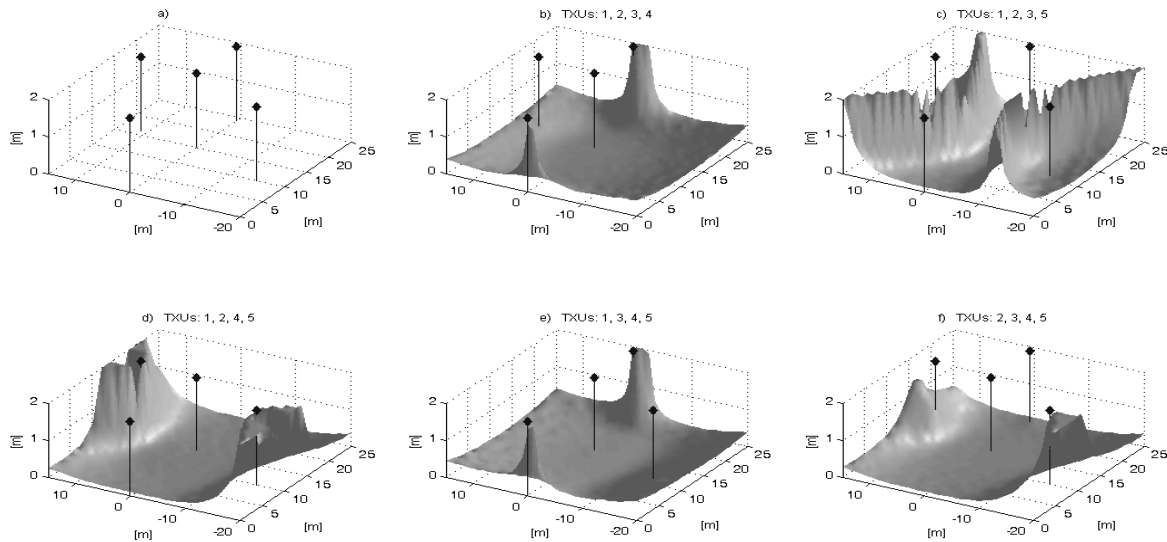

Fig. 5. Positioning uncertainty for various transmitter configurations (b-f), localization of transmitters (a) - stems correspond to the transmitter positions.

The influence of both uncertainty contributors on the total positioning uncertainty strongly depends on the transmitter configuration used for the positioning. Results of simulations illustrating this phenomenon are shown in Fig. 5. The graphs are drawn for combinations of four transmitters from the five transmitter set. The simulations were performed according to the algorithm described in section IV.B.

A significant increase in uncertainty observed for some configurations is a result of singularities that appear in the analytical solution.

The presented results were used for the preparation of data necessary for the transmitter selection. A map of the considered area with the best transmitter configurations is shown in Fig. 6.

The number of transmitter configurations providing specified positioning accuracy can be evaluated for each reference point. Results obtained for the assumed positioning uncertainty threshold equal to 0.5 m are shown in Fig. 7. These results are satisfying especially from the point of view of the proposed method for calculation of initial position and thus a choice of initial transmitter configuration.

The selection of the transmitter configuration in accordance with the proposed algorithm results in the decrease of the overall positioning uncertainty. A graph of the positioning uncertainty for the considered set of transmitters is presented in Fig. 8. The maximum uncertainty was reduced to less than 0.5 m.

V. UWB POSITIONING SUBSYSTEM DEMONSTRATOR

A. UWB Transmitters

The demonstrator was developed to verify the proposed UWB positioning system concept. The infrastructure part of the demonstrator comprises five transmitters. In order to synchronize the transmitting units they were connected using screened twisted pair. Trigger and clock signals were transmitted in LVDS (Low-Voltage Differential Signaling) format. The LVDS standard was chosen because of its immunity to interference.

A transmitter block diagram is presented in Fig. 9. The transmitter controller is responsible for the delayed generation of the packet in response to the trigger signal. The sequence of

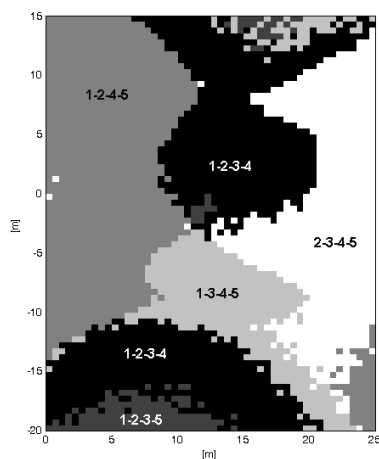

Fig. 6. Transmitter configurations providing minimum positioning uncertainty.

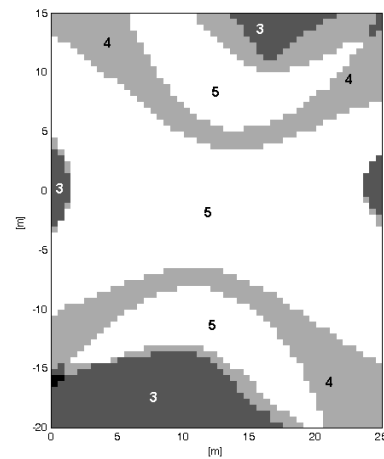

Fig. 7. Numbers of configurations providing an uncertainty lower than 0.5 m.

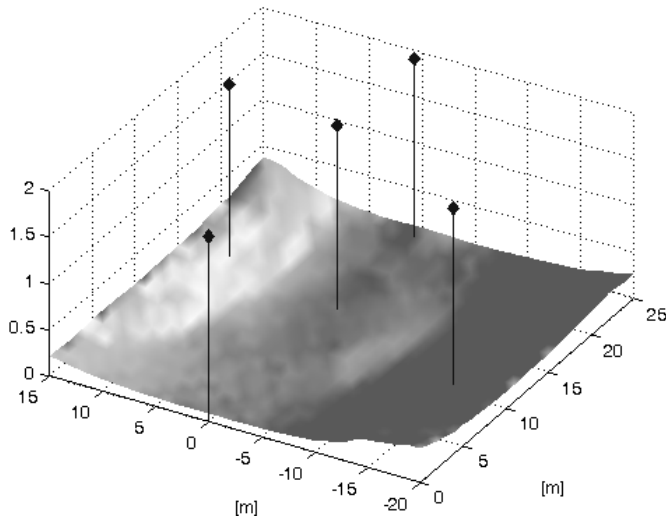

Fig. 8. Positioning uncertainty calculated for a set of five transmitters.

pulses comprising the packet is converted to UWB pulses in the UWB pulse generator.

The construction of the UWB generator is based on a step recovery diode. The impulse at the diode output is formed with a shorted microstrip line. A set of bandpass filters limits the signal spectrum to 3.4 – 4.8 GHz. The generated UWB pulse and the pulse spectrum are presented in Fig. 10. The pulse is transmitted with a circular monopole ultra-wideband antenna, developed for the demonstrator.

The packet content is in accordance with the general structure presented in Fig 3. Information is sent using OOK (On-Off Keying) modulation. The interval between UWB pulses comprising transmitted packets is equal to 300 ns. The value was chosen with respect to the propagation channel response. The interval value guarantees that when the pulse reaches the receiver input, reflections originating from the previous pulse will be negligible. Temporal parameters of the transmission implemented in the demonstrator are included in Table 3. A relatively long T_{CYCLE} period results from the time-consuming TDOAs processing in the PC.

B. UWB Receiver

An UWB receiver block diagram is presented in Fig. 11. The antenna design is the same as used in the transmitter units. The received UWB pulses are converted to LVDS signals in the UWB pulse detector block. It provides signal filtration, amplification, pulse extension, and conversion to LVDS levels. Its operation is similar to a typical leading edge detector [12].

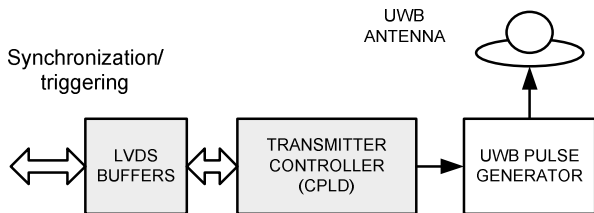

Fig. 9. Transmitter block diagram.

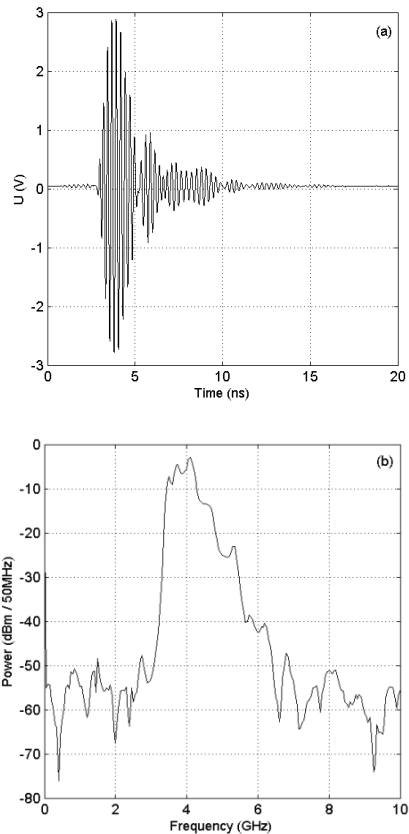

Fig. 10. Test pulse (a) and its spectrum (b).

The packet decoder retrieves the start and stop sequences and identifies the source of the packet. The decoded sequences are used for triggering Acam’s GP2 - time-to-digital converter (TDC). The receiver controller arms the TDC, acquires the measurement results and sends them to the PC via a USB interface. The functions related to packet detection and measurement control were implemented in FPGA circuit (XILINX’s ML-403 board). The whole circuit provides a resolution of the TDOA measurement equal to 65 ps. The TDOA values are transferred to the PC where their analysis and the position calculations take place. Detailed description of the receiver operation can be found in [11].

Proper system operation requires calibration data i.e. the delays between UWB pulses delivered to the transmitter

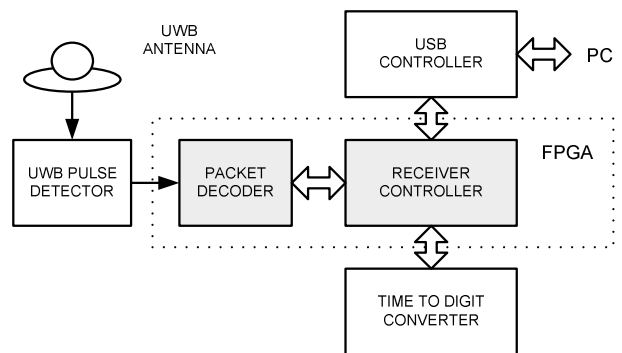

Fig. 11. Receiver block diagram.

antennas ($T_{TRIG} + T_{DEL}$). These values correspond to intentional delays in triggering the transmitters as well as delays originating from propagation of trigger signals via cables. Subtracting the calibration data from the measured delays gives the TDOA values.

VI. SYSTEM DEMONSTRATOR INVESTIGATIONS

A. Test Objectives

The main objective of the performed tests was verification of the system concept in a real environment. Experiments were focused on functional aspects of the system (starting the system operation when entering the covered area, influence of the propagation channel, influence of the transmitter distribution on the obtained results) and also on the accuracy achievable in field conditions. The system was tested during two measurement sessions carried out in summer and in winter conditions. Both sessions took place at Technical University of Chemnitz, Germany.

B. Test Procedure

The experimental setup included:

- 1) the UWB subsystem demonstrator consisting of five battery operated UWB transmitters mounted on tripods,
- 2) one UWB measuring receiver installed on the test vehicle roof bars,
- 3) a test vehicle equipped with a Leica 1200 DGPS system used for reference measurements,
- 4) a notebook computer with a software supporting the result acquisition,
- 5) a laser distance meter Leica Disto A5.

The UWB antenna and the RF part of the RXU were mounted on the vehicle's roof.

The test scenario consisted of various maneuvers in the system operation area. During each test ride the results from the DGPS and the UWB systems were recorded.

The test sessions required the special preparation of the parking area. In order to provide a good quality of the reference results, the chosen parking lot is an open area with no obstacles (trees or high buildings) which might disturb the reception of satellite signals. After placing the transmitters, their positions were measured with the Leica DGPS system. The results of measurement were used for the determination of TXUs coordinates, required by the positioning algorithm. The placement of TXUs is depicted in Fig. 13.

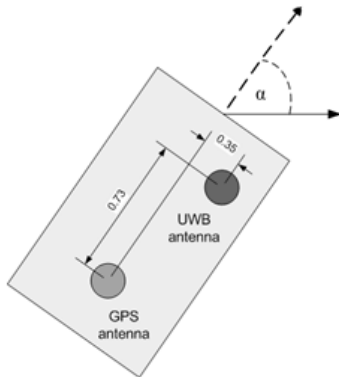

Fig. 12. Location of GPS and UWB antennas on the vehicle's roof.

TABLE III
TEMPORAL PARAMETERS OF TRANSMISSION IMPLEMENTED IN THE DEMONSTRATOR

Interval between pulses in the packet	0.3 μ s
Intentional transmission delay T_{DEL}	20 μ s
T_{CYCLE} period	5000 μ s
Packet parameters:	length time
Preamble	8 bits 2.4 μ s
Start sequence	5 bits 1.5 μ s
Stop sequence	5 bits 1.5 μ s
TX identifier	24 bits 7.2 μ s
Total packet	42 bits 12.6 μ s

The tests were preceded by the calibration measurements. The investigated system demonstrator was previously calibrated in laboratory conditions, but the tests were performed outdoor at ambient temperatures close to 0 C. The calibration consisted in measuring the TDOAs at a few reference points. The positions of those points were precisely measured and the correct TDOA values (based on distances from all IPUs) were calculated. The differences in obtained values were used for correction of calibration data.

The evaluation of the UWB positioning system consisted in a comparison of the results with the reference measurements collected by an application supporting the Leica DGPS receiver. The data acquisition software was run on the same notebook in order to provide time synchronization of results. All results were marked with time stamps given with millisecond resolution.

C. Test Results Processing

Although both systems provide 3D coordinates, only 2D coordinates were taken into account during the error analysis. For the applications considered within the SAFESPOT project [22], 2D vehicle coordinates are sufficient.

The analysis of recorded results required taking into account different positions of GPS and UWB antennas on the vehicle's roof (see Fig. 12).

The coordinates obtained with the UWB system were recalculated using formulae (5) and (6). The vehicle heading α was determined using the recorded DGPS positions.

$$x_{UWBnew} = x_{UWB} - b \cdot \cos(\alpha) - b \cdot \sin(\alpha) \quad (5)$$

$$y_{UWBnew} = y_{UWB} - b \cdot \sin(\alpha) - b \cdot \cos(\alpha) \quad (6)$$

where

α – vehicle heading,

x_{UWBnew}, y_{UWBnew} – new coordinates,

x_{UWB}, y_{UWB} – previous coordinates,

a, b – distance between antennas (in our case: $a=0.35$ m, $b=0.73$ m).

D. Exemplary Test Results

An exemplary trajectory recorded during test sessions is presented in Fig. 13. The vehicle heading during the ride is marked with arrows. Fig. 13 contains only raw results directly recorded with the two systems.

The implementation of averaging (a moving average of 5 samples) and the corrections defined by (5) and (6) resulted in a better agreement with the reference values (Fig. 14).

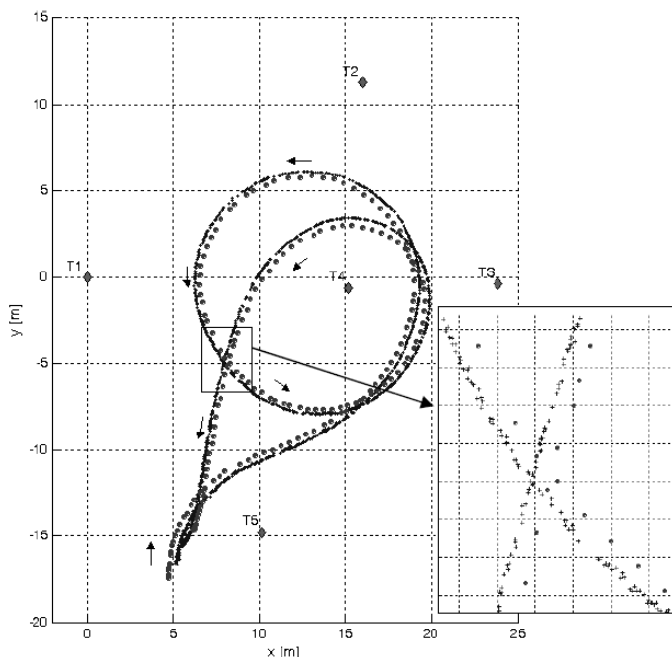

Fig. 13. Trajectories recorded with the DGPS system and the UWB demonstrator (o – DGPS results, + – UWB results); T1...T5 – TXUs positions.

The number of results delivered by the UWB positioning system is significantly higher than the number of the reference points. The comparison of the obtained results with the reference ones was based on the attached time stamps i.e. the results were compared to the closest (in time) reference values. The errors versus time are presented in Fig. 15. As seen in these figures, in the majority of points, the errors of x and y coordinates do not reach 0.8 m. The total error is lower than 0.9 m.

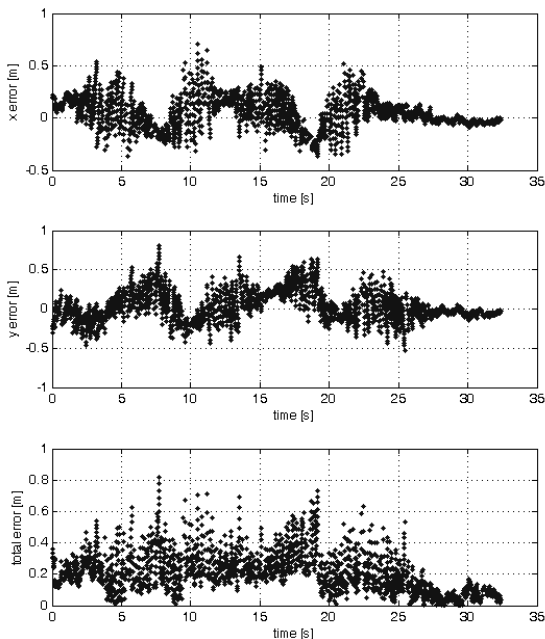

Fig. 15. Positioning errors.

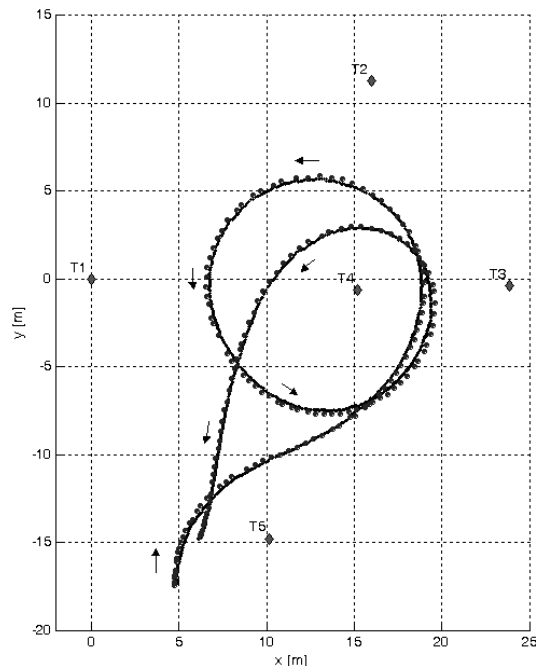

Fig. 14. Trajectories recorded with the DGPS system (circles) and the UWB demonstrator after correction of UWB results.

The observed positioning errors are bigger than the uncertainties obtained with the simulations presented in section IV. The leading edge detector used in the demonstrator is a source of systematic TDOA measurement errors. Their values depend on the ratio of pulse amplitudes coming from different transmitters, so it changes over the system operation area. The difference in pulse amplitudes emitted by particular transmitters and the difference in antenna patterns also contribute to these errors. The algorithm for systematic error reduction implemented in the demonstrator [8] is not able to completely remove these systematic errors.

The DGPS system besides positioning coordinates provides information on their quality. During the test the number of satellites used was equal to 8. Changes of coordinate quality factor are depicted in Fig. 16. These values provide a two third probability confidence interval of the acquired position. Fig 16 illustrates that the errors of the DGPS measurements were in the centimeter domain, thus allowing the usage of these measurements as a position reference.

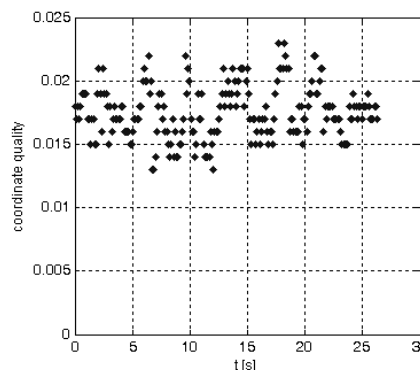

Fig. 16. Coordinate quality factor versus time during measurement session.

The investigations of the system demonstrator were performed in LOS (Line of Sight) conditions. The operation in NLOS (Non Line of Sight) conditions can be a source of serious errors due to signal reflections and delays in the pulse arrival.

In the considered system architecture a lack of direct propagation path from one of transmitters will result in a change of one or two TDOAs. If the obtained position is significantly different from the previous results it can be easily filtered out.

We propose two solutions to this problem. The first one consists in a careful system planning. Placing the UWB antennas on the vehicles' roofs or increasing the number of UWB transmitters should help. Another approach can be based on typical INS (Inertial Navigation System) systems tracking the movement trajectory [17].

VII. CONCLUSIONS

In the paper the proposal of an ultra-wideband vehicle positioning system has been presented. Such systems could be used in places where precise determination of the object position is especially important or places where localization with commonly used systems (e.g. GPS) is difficult or even impossible.

Unfortunately, the current European regulations limit applications of UWB positioning systems to places "in which the shielding will typically provide the necessary attenuation to protect radio communication services against harmful interference" [1]. Tunnels and underground parking areas can be regarded as such places. The limits put on the emitted signal level result in a reduction of the transmission range to a few hundred meters. Covering large areas requires an expansion of the system infrastructure (i.e. adding new transmitters).

Experiments confirm that UWB positioning is promising technology able to provide sub-meter accuracy.

The proposed unilateral system architecture proved to be efficient; the UWB positioning system can be significantly simplified without scarifying its accuracy and the speed of the position calculation.

The obtained results have been achieved by using relatively simple hardware solutions and simple data processing algorithms. The system range as well as the positioning accuracy can still be increased by an improvement of hardware (transmitters, antennas and receivers) and by the implementation of more advanced algorithms. However, the developed UWB positioning subsystem demonstrator is a good basis for further investigation of this technology.

ACKNOWLEDGMENT

The authors would like to thank all partners within SAFESPOT especially Norman Mattern and Robin Schubert with Chemnitz University, Germany for their cooperation.

REFERENCES

[1] Commission of the European Communities, "Commission Decision 2007/131/EC on allowing the use of the radio spectrum for equipment using ultra-wideband technology in a harmonized manner in the Community," Brussels, 21 Feb., 2007.

[2] Commission of the European Communities, "Commission Decision 2009/343/EC amending Decision 2007/131/EC" Brussels, 21 Apr. 2009.

[3] B. Fang, "Simple solutions for hyperbolic and related position fixes," *IEEE Transactions on Aerospace and Electronic Systems*, vol. 26, pp. 748-753, Sep. 1990.

[4] Federal Communications Commission (FCC), "Revision of Part 15 of the Commission's rules regarding ultra-wideband transmission systems," *First Report and Order*, ET-Docket 98-153, FCC 02-48, 14 Feb. 2002.

[5] J. Fernandez-Madriral, E. Cruz-Martin, J. Gonzalez, C. Galindo, and J. Blanco, "Application of UWB and GPS technologies for vehicle localization in combined indoor-outdoor environments," in *Proc. 9th International Symposium on Signal Processing and ITS Applications*, Sharjah, Feb. 2007, pp. 1-4.

[6] W. Foy, "Position-location solution by Taylor-series estimation," *IEEE Transactions on Aerospace and Electronic Systems*, vol. AES-12, pp. 187-194, Mar. 1976.

[7] J. Kolakowski, R. Michnowski, and P. Makal, "Application of Time to Digital Converter In I-UWB Positioning System Receiver," in *Proc. 6th European Radar Conference*, Rome, 2009, pp. 366-369.

[8] J. Kolakowski and P. Makal, "A Reduction of Systematic Errors In the UWB Positioning System", presented at 4th International Conference on Broadband Communications, Information Technology and Biomedical Applications, Wroclaw, 2009 [CD-ROM].

[9] J. Neering, C. Fischer, M. Bordier, and N. Maizi, "Optimal sensor configuration for passive position estimation" in *Proc. IEEE Location and Navigation Symposium*, Monterey, 2008, pp. 951-960.

[10] I. Oppermann, M. Hamalainen, and J. Inatti, *UWB Theory and Applications*, New York: John Wiley & Sons Ltd, 2004.

[11] P. Ray and A. Mahajan, "Optimal configuration of receivers in an ultrasonic 3D position estimation system by using genetic algorithms," in *Proc. American Control Conference*, vol. 4, Chicago, 2000, pp. 2902-2906.

[12] J. H. Reed, *An Introduction to Ultra Wideband Communication Systems*, Englewood Cliffs, NJ: Prentice Hall, 2005.

[13] M. Rydstrom, E. Strom, A. Svensson, and L. Reggiani, "An Approach to Positioning Road-Users in a Telematics Network," in *Proc. 8th International Symposium on Autonomous Decentralized Systems*, Sedona, 2007, pp. 335-343.

[14] Z. Sahinoglu, S. Gezici, and I. Güvenc, *Ultra-wideband Positioning Systems: Theoretical Limits, Ranging Algorithms, and Protocols*, Cambridge: University Press, 2008.

[15] M. Schlingelhof, D. Betaille, P. Bonnifat, and K. Demaseure, "Advanced positioning technologies for co-operative systems," *IET Intelligent Transportation Systems*, vol. 2, issue 2, pp. 81-91, Jun. 2008.

[16] *Consolidation Report of User Needs and Requirements for Positioning, Local Dynamic Maps and Vehicular Ad Hoc Networks*, D3.2.3 SINTECH deliverable. V.2.0, 26 Oct. 2006.

[17] I. Skog and P. Händel, "In-Car Positioning and Navigation Technologies - A Survey," *IEEE Transactions on Intelligent Transportation Systems*, vol. ITS-10, pp. 4-21, Mar. 2009.

[18] J. Smith and J. Abel, "The spherical interpolation method of source localization," *IEEE Journal of Oceanic Engineering*, vol. 12, issue 1, pp. 246-252, Jan. 1987.

[19] J. Taylor, *An Introduction to Error Analysis, The Study of Uncertainties in Physical Measurements*, 2nd ed., Sausalito: University Science Books, 1997.

[20] D. Torrieri, "Statistical Theory of Passive Location Systems," *IEEE Transactions on Aerospace and Electronic Systems*, vol. 20, pp. 183-198, Mar. 1984.

[21] Van Yem Vu, A. Benlarbi Delai, and L. Le Cloirec, "Digital and Super-Resolution Ultra Wideband Inter-Vehicle Localization System," in *Proc. 1st International Conference on Communications and Electronics*, Hanoi, 2006, pp. 446-450.

[22] G. Vivo, P. Dalmasso, and F. Vemacchia, "The European Integrated Project "SAFESPOT" - How ADAS applications co-operate for the driving safety," in *Proc. Intelligent Transportation Systems Conference*, Seattle, Sep. 2007, pp. 624-629.

[23] Series 7000 Real Time Location System - application notes. Available: <http://www.ubisense.net>

[24] Sapphire Ultra-Wideband Technology Real Time Locating System - application notes. Available: <http://www.multispectral.com>

