

FIELD TESTING OF ACOUSTIC CLEANING SYSTEM WORKING IN 670MW_{TH} CFB BOILER

Paweł Mirek*

Częstochowa University of Technology, Faculty of Environmental Engineering and Biotechnology,
Institute of Advanced Energy Technologies, ul. Dąbrowskiego 69, 42-200 Częstochowa, Poland

The article reports the results of measurements of the acoustic pressure of acoustic waves generated by acoustic dust cleaners mounted in the convection pass of the 670MW_{th} Circulating Fluidised Bed boiler. Based on measurements carried out and the spectral analysis of recorded signals it was found that the level of acoustic pressure generated by acoustic cleaners for the frequency of 100 Hz was too low for the efficient cleaning of the heated surfaces of the reheater RH2 and superheater SH3.

Keywords: acoustic cleaners, circulating fluidized bed, ash fouling

1. INTRODUCTION

The use of an effective system for cleaning ash fouling off the heated surfaces in fossil fuel-fired Circulating Fluidised Bed (CFB) boilers determines the maintaining of:

- the maximum thermal efficiency of the boiler,
- the maximum efficiency of electrofilter operation,
- the limited consumption of energy required for forcing the flue gas through the boiler,
- the CO₂ emission per unit of a useful heat at a minimum level (Pronobis, 2002; Zbogar et al., 2009).

The effectiveness of operating such a system is conditioned by a number of factors, of which the following are most commonly mentioned: the place of installation, method, as well as the frequency of ash buildup removal. Among ash removals used currently, soot blowers enjoy the greatest popularity in CFB boilers. They owe their popularity primarily to high operation efficiency resulting, among other things, from the parameters of the working medium ($p = 1.5\div 4.0$ MPa; $T = 673\div 773$ K). Unfortunately, as shown by operational experience, in addition to their high operation costs, these devices are also the source of many problems. These include the erosive action of ash carried away with the steam stream and insufficient cleaning of surface in locations inaccessible to the steam stream (Fig. 1) (Hare et al., 2010).

An alternative method of ash fouling removal is by using an acoustic wave of a high sound intensity level and a low frequency. The source of such a wave are acoustic cleaners supplied with compressed air or liquefied gas with parameters as shown in Table 1.

The principle of operating acoustic cleaners relies on the short-time emission of a high-intensity low-frequency acoustic wave, whose energy, on the one hand, sets the dust particles carried in the gas stream in oscillatory motion thus preventing them from agglomeration, and on the other hand, prevents

*Corresponding author, e-mail: pmirek@neo.pl

from the formation of high-temperature buildup. Achieving the optimal cleaning effects depends largely on: the type of dust and its moisture content, the acoustic pressure level, the arrangement of acoustic cleaners in the convection cage, the feed air pressure and the device's performance characteristic (typically, 10÷15 s of sound emission every 5÷10 min.). As the acoustic cleaner operation parameters are determined in anechoic chamber conditions, the optimal arrangement of these devices is a task of a high level of complexity. During the design process determining acoustic wave properties it is impossible to be accomplished in the hard accessible locations of convection bundles. Therefore, the performance characteristic of acoustic cleaners should be each time verified on a real facility. In most cases, the efficiency of acoustic cleaners is assessed based on the measurements of the temperature of flue gas or a steam flowing through the boiler superheater tubes in the location of their installation. Complementary measurements can be the measurements of the acoustic pressure generated by acoustic cleaners combined with the spectral analysis of sonic waves, as described in this paper.



Fig. 1. Superheater failure caused by erosive action of ash carried away with the steam stream of soot blower's jet. Arrow indicates the location of steam leakage

Table 1. Typical parameters of acoustic cleaners supplied with compressed air and liquefied gas

	Pneumatic acoustic cleaner	LP gas acoustic cleaner
Sound pressure level (SPL), dB	100÷150	over 170
Frequency, Hz	60÷250	100
Max working temperature, °C	up to 1250	up to 1500
Compressed air pressure, MPa	ok. 0.4÷0.6	approx. 0.6
Compressed air consumption, m ³ /s	20÷40	80
LP gas consumption, g/pulse	-	approx. 0.4

2. EXPERIMENTAL SET-UP

Experimental tests were carried out during the shutdown period of the 670MW_{th} CFB boiler operated at the PGE GiEK S.A. Turów Power Plant. The boiler is equipped with four Nirafon NI-100SS type acoustic cleaners, which are positioned in the convection pass (cross-sectional area 20.266×8.724m²) between the tube bundles of the reheater RH2 and superheater SH3, according to the schematic diagram shown in Fig. 2.

The operation parameters of the acoustic cleaners are given in Table 2. The acoustic cleaners are made in the form of a horn loudspeaker of material SS2343 that is resistant to high temperature (up to 800 °C).

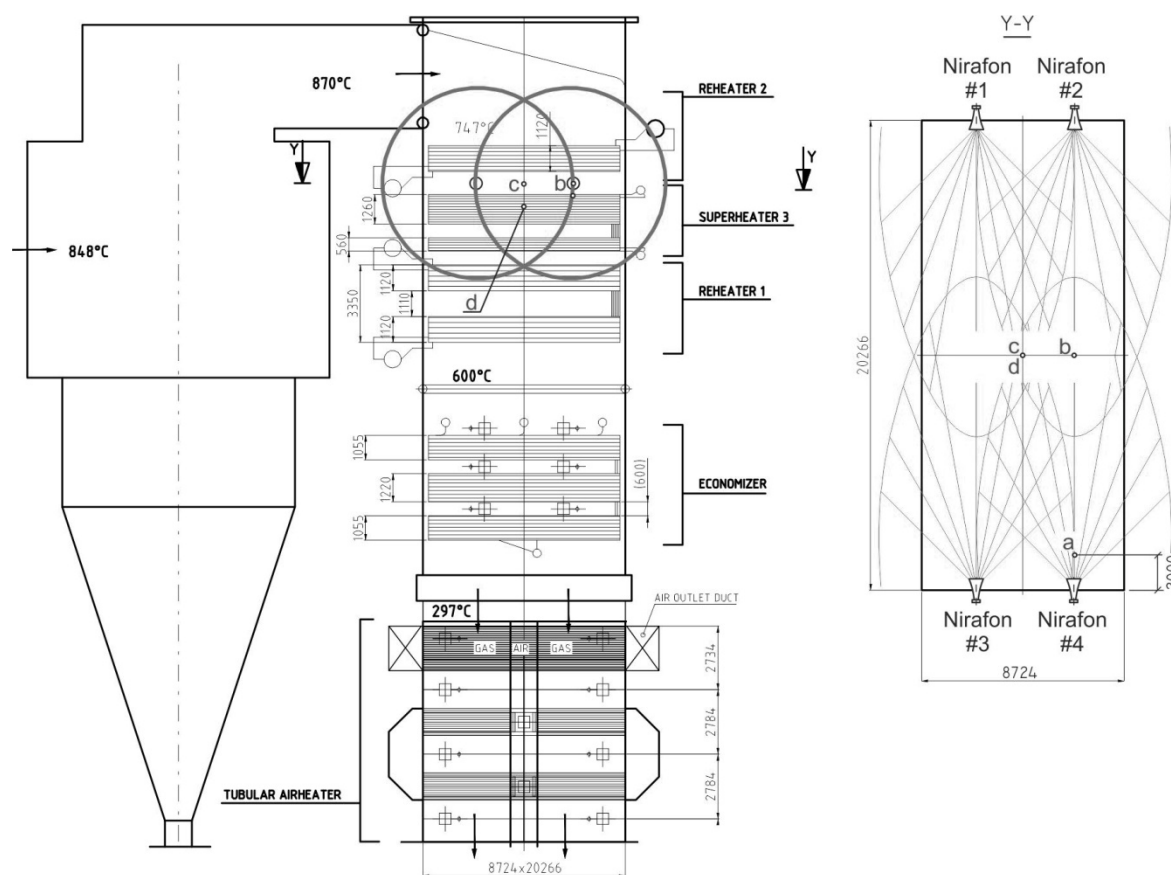

Fig. 2. Schematic diagram of acoustic cleaners installation in the convection pass of 670MW_{th} CFB boiler working in PGE GiEK S.A. Turów Power Plant: *a, b, c, d* - location of microphone G.R.A.S. 40BH

Table 2. Technical specification of acoustic cleaner Nirafon NI-100SS

Frequency:	Hz	100
Sound pressure level:	dB	approx. 150 (at distance of 1m from NI-100)
Compressed air:		
- pressure	MPa	0.6
- consumption	Nm ³ /s	0.04 for cleaning; 0.002 for cooling
Material	-	SS 2343 (DIN 17445); (max. 800 ⁰ C)

Compressed air is fed to each of the acoustic cleaners by a 25 mm-diameter line through a connection assembly consisting of: a cut-off valve, a particulate filter, a pressure regulator and a solenoid valve. As can be seen from Table 2, compressed air is used both for cleaning and for cooling the membrane of the sound generating device. The acoustic cleaners were pulse controlled. The length of the sound emission pulse was $t_{imp} = 4$ s and was able to be set in the range of 1÷30 s. The interval between sound emissions was $t_p = 1$ s and could be changed in the range of 2÷5 s. The time interval between sound emission sequences was $t_s = 5$ min and could be varied in the range of 1÷60 min.

3. METHODS AND MEASUREMENT EQUIPMENT



The acoustic pressure level was measured using a microphone with an extended measuring range in the following locations:

- in the acoustic wave propagation axis of acoustic cleaners #2 and #4 at a distance of 2 m from the device's outlet (the measurement point *a* - Fig. 2) and in the central part of the convection

- cage (the measurement point *b* – Fig. 2),
- between the convection bundles of the reheater RH2 and the superheater SH3 at the measurement point *c* (Fig. 2), and
- in the convection bundle of the superheater SH3 (the eighth tube row) – the measurement point *d* (Fig. 2).

A 1/4" 40BH type microphone supplied by G.R.A.S., operating with a 26AC type preamplifier, was used in the acoustic pressure and acoustic wave frequency spectrum measurements. The employed microphone had the measuring range extended up to 194dB and enabled the linear measurement of sound intensity in the range from 10Hz to 15kHz. The detailed specifications of the microphone and the preamplifier are shown in Table 3.

Table 3. Technical data of High-pressure Microphone G.R.A.S. Type 40BH and preamplifier G.R.A.S. Type 26AC

¼" High-pressure Microphone G.R.A.S. Type 40BH		
Frequency response:	10 Hz - 20 kHz ± 2 dB	
Nominal sensitivity:	0.4 mV/Pa	
Dynamic range:	Upper limit (3% distortion): 194 dB	
Capacitance:	6pF	
Temperature range:	-40 °C to +150 °C	
¼" Preamplifier G.R.A.S. Type 26AC		
Frequency response (18 pF/small signal):	2.5 Hz - 200 kHz ± 0.2 dB	
Slew rate:	20 V/μs	
Input impedance:	20G Ω, 0.5 pF	
Output impedance (Cs = 20 pF, f = 1000 Hz):	75 Ω	

In the measurements of the signal outputted from the microphone, an LMS V8-E 8-channel measuring card with a sampling frequency of 204.8kHz/channel and 24-bit signal processing was employed. The card was incorporated in the LMS SCM01 module and operated with the LMS Test.Lab 11B software. In each of the cases under examination, the acoustic cleaners' operation was enabled manually and lasted for approx. 1 s.

4. 4. RESULTS AND DISCUSSION

4.1. Measurements of acoustic pressure

Figure 3 illustrates the time variation of acoustic pressure generated by acoustic cleaner #4 at measurement point 'a' located in the wave propagation axis (Fig. 2).

As can be noticed from Fig. 3, the root-mean-square (RMS) value of acoustic pressure recorded by the microphone in the time interval of 1.23÷1.70s was 148.43dB.

Figure 4 shows the time variation of acoustic pressure generated by all acoustic cleaners at measurement point 'b' (see Fig. 2).

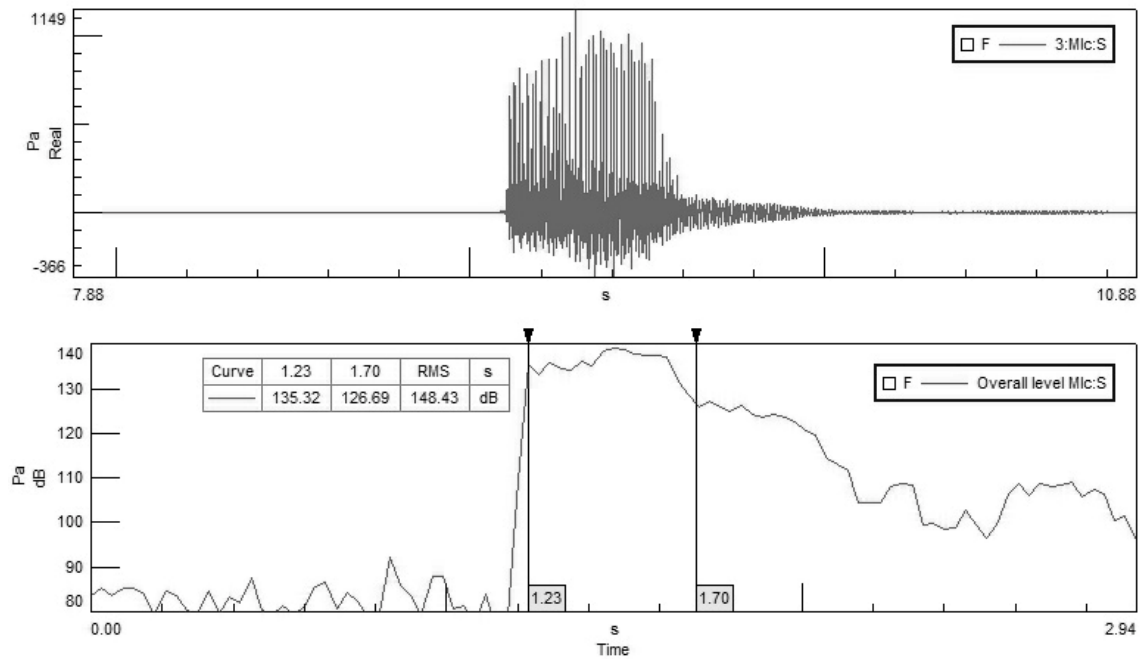

Fig. 3. Time variation of acoustic pressure generated by acoustic cleaner #4 at the measurement point 'a' located in the wave propagation axis

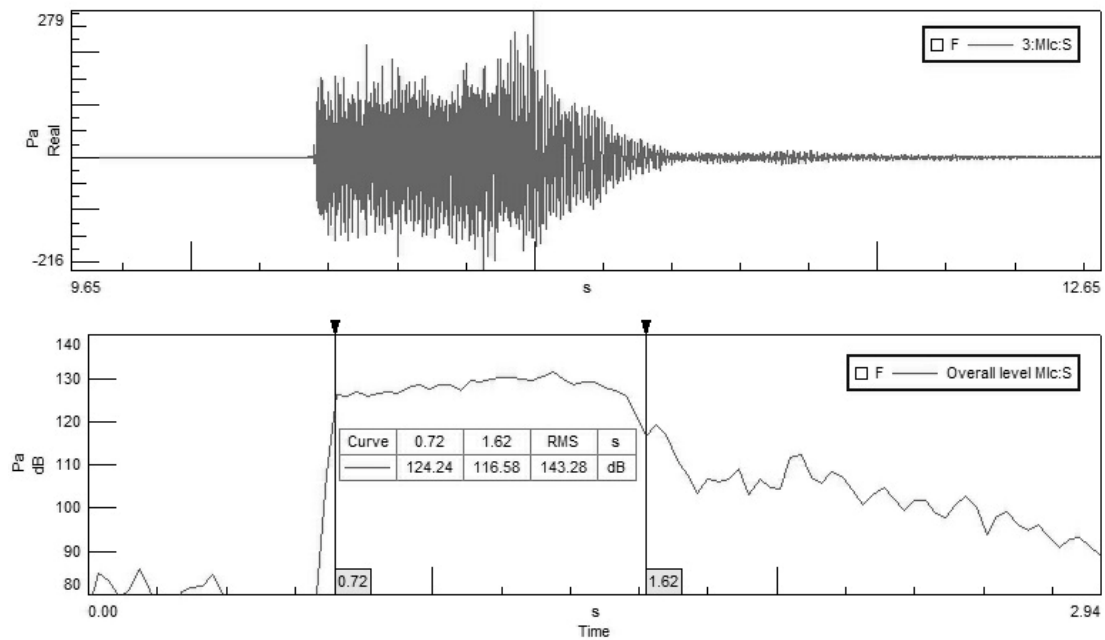

Fig. 4. Time variation of acoustic pressure generated by acoustic cleaners at the measurement point 'b' (wave propagation axis of acoustic cleaners #2 i #4)

As can be noticed from Fig. 4, in spite of the fact that the distance of the microphone from the acoustic cleaners' outlet has been increased five times, the measured acoustic pressure value is relatively high, being 143.28dB. This means that due to the action of all the acoustic cleaners and the reflection of sonic waves in the convection cage, the sound intensity at measurement point 'b' is merely 3 times lower than the sound intensity recorded at point 'a'.

Figure 5 shows the values of acoustic pressure measured in the central part of convection cage (measurement point 'c' – see Fig. 2) between the reheater RH2 and the superheater SH3.

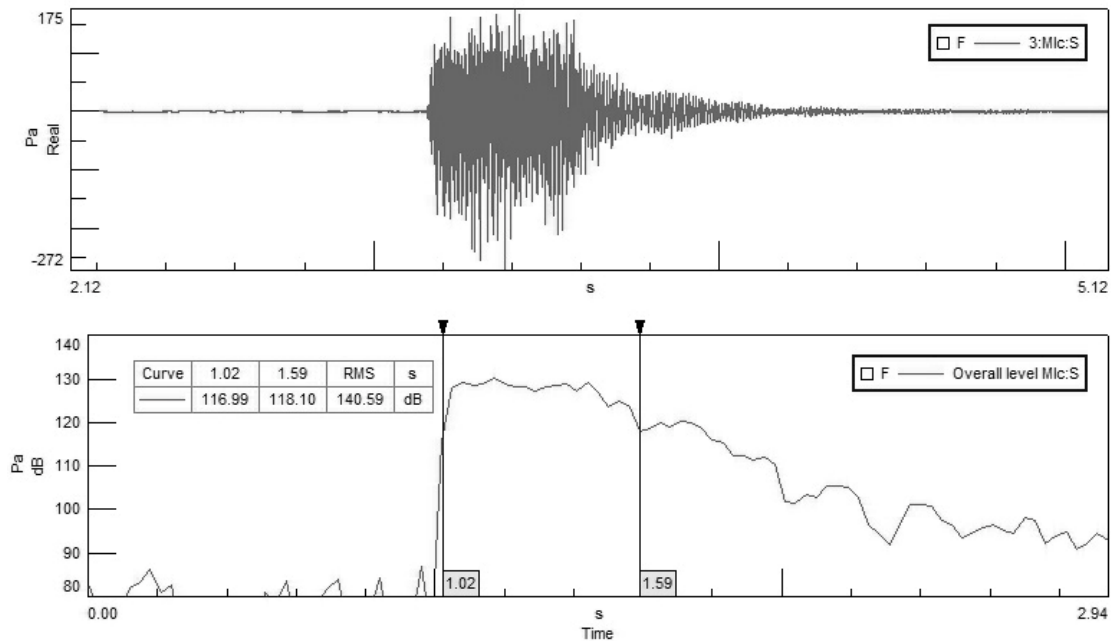

Fig. 5. Time variation of acoustic pressure generated by acoustic cleaners at the measurement point 'c' between the reheater RH2 and the superheater SH3

As can be seen from Fig. 5, the acoustic pressure value measured at the measurement point 'c' is lower by approx. 3 dB compared to measurement point 'b', amounting to 140.59 dB. This means that in the central part of the convection cage the acoustic pressure value is almost ten times lower than that occurring at the distance of 1m from the acoustic cleaner's outlet (see Table 2).

The last location of acoustic pressure measurement was the point located near the eighth row of the superheater SH3, that is in the region where the acoustic wave is expected to be much weaker compared to the open space where measurement points 'a', 'b' and 'c' are located. Figure 6 shows the value of acoustic pressure measured at the measurement point 'd' (Fig. 2).

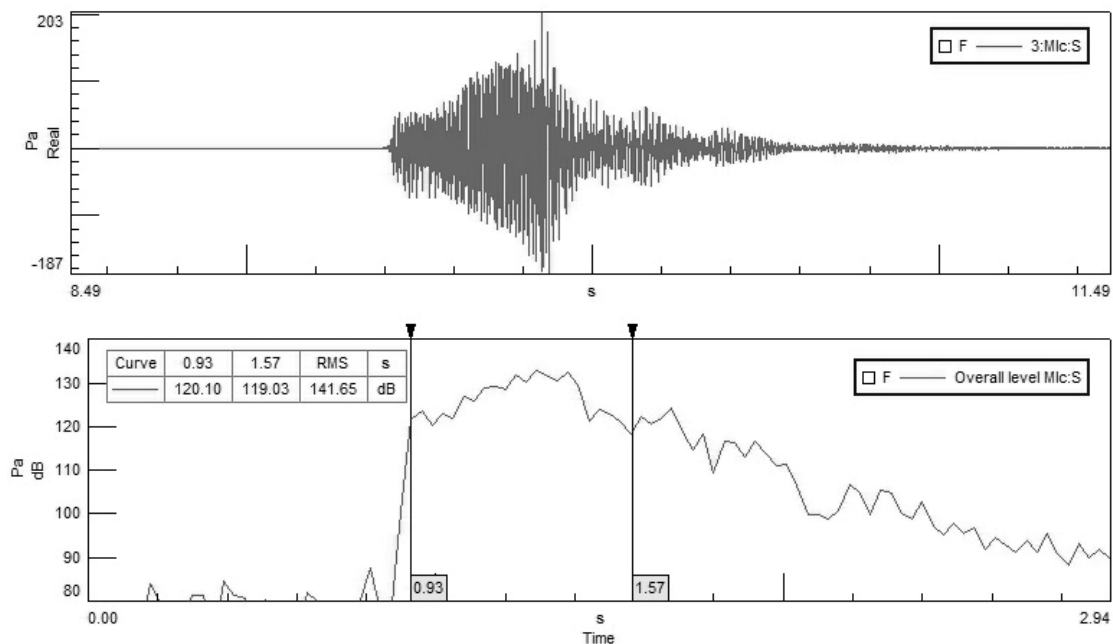

Fig. 6. variation of acoustic pressure generated by acoustic cleaners in the eighth row of the superheater SH3 (measurement point 'd')

As indicated by Fig. 6, the value of acoustic pressure measured in the middle of the SH3 superheater's convection bundle was 141.65dB. This means that the acoustic wave has not weakened in the tight tube bundle of the SH3 superheater and, in the flue gas flow conditions, will act on dust settling on the tube surface. As the efficiency of acoustic cleaner action is the highest in the range of low sound wave frequencies, the acoustic pressure measurements were supplemented with the spectral analysis of the recorded sonic waves.

4.2. Sound wave spectral analysis

As can be seen from Table 2, the maximum level of acoustic pressure generated by the Nirafon NI-100SS acoustic cleaner falls to the frequency of 100Hz. To verify these data, the signals recorded at measurement points 'a', 'b', 'c' and 'd' were subjected to frequency analysis using the LMS Test.Lab 11B software.

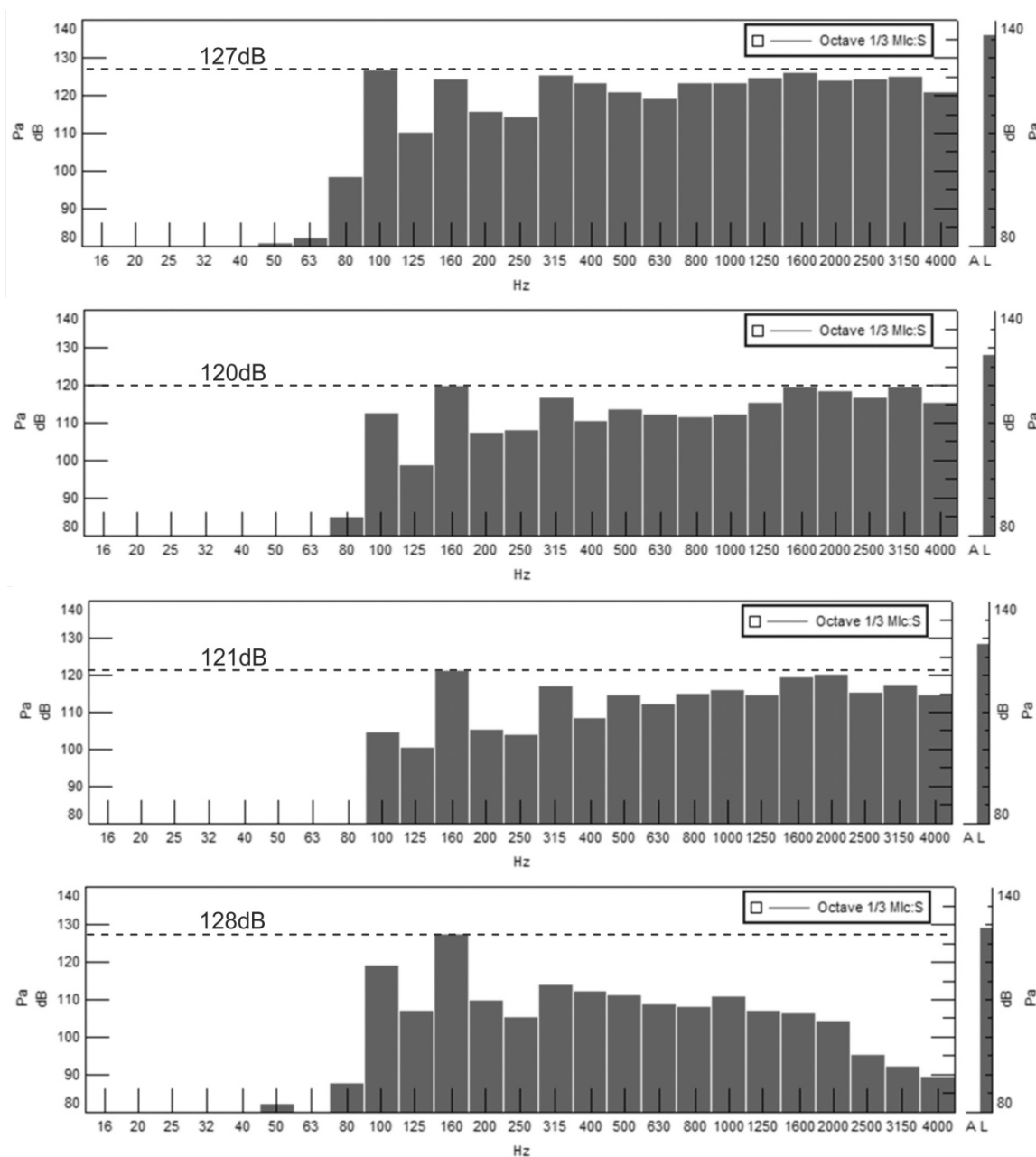

Fig. 7. Frequency spectrum of the acoustic wave generated by the acoustic cleaners in the convection cage of the reheater RH2 and the superheater SH3 at: a) measurement point 'a', b) measurement point 'b', c) measurement point 'c', d) measurement point 'd'

Figure 7 shows the frequency spectrum of the acoustic wave generated by the acoustic cleaners in the convection cage of the reheater RH2 and the superheater SH3 at the measurement points 'a', 'b', 'c' and 'd'. As can be seen from Fig. 7, a third-octave filter was used in the analysis.

As shown by Fig. 7a, the maximum acoustic pressure level in the acoustic wave propagation axis at the distance of 2m from the outlet of acoustic cleaner #4 falls to the frequency of 100Hz and amounts to 127dB, while high values of this parameter were also recorded for frequencies of 160, 315, 1600 and 3150Hz. This suggests that, in spite of the high RMS value of the acoustic pressure of the wave generated by the acoustic cleaner (148.43dB - see Fig. 3) for the frequency of 100Hz, the energy carried by the wave is too low to break the dust adhesion forces. This is confirmed by visual observations of the RH3 reheater's tubes where unilateral tangential ash deposits have been found (Fig. 8a).

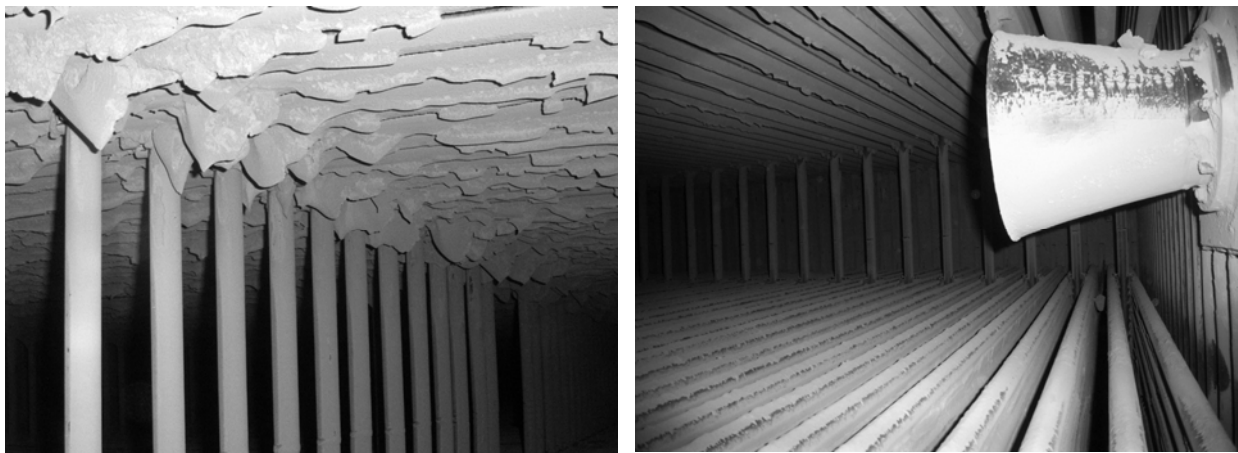

Fig. 8. Ash deposits on tubes of: a) reheater RH2, b) superheater SH3 (lower row of tubes)

A similar regularity can be observed at the measurement point 'b' (Fig. 7b), where the maximum level of acoustic pressure generated by the acoustic cleaners falls to the frequency of 160Hz and amounts to 120 dB. As indicated by Fig. 7b, a similar pressure value was recorded for frequencies of 1.6kHz and 3.15 kHz.

In the case of the measurement point 'c', the maximum acoustic pressure value was recorded, as previously, for the frequency of 160Hz, although not much smaller values of these parameters can also be noticed for frequencies of 1.6 and 2.0kHz (Fig. 7c). In the middle of the SH3 superheater's convection bundle, where the measurement point 'd' is located, the highest acoustic pressure of 128dB was recorded for a frequency of 160Hz, while higher frequencies were clearly damped there (Fig. 7d). The 100Hz-frequency wave did not exceed the level of 120dB at that point.

To sum up, it can be noted that the 100Hz-frequency sound wave generated by acoustic cleaner #4 at measurement point 'a' and by acoustic cleaners #1, #2, #3 and #4 at measurement points 'b', 'c' and 'd' reached an acoustic pressure level in the range of 120÷130 dB. For this reason, the energy carried by sonic waves generated by the acoustic cleaners in the 670 MW_{th} CFB boiler's convection cage is too low for the efficient cleaning of the reheater's RH2 and the superheater's SH3 surfaces.

5. CONCLUDING REMARKS

The tests carried out on the Nirafon NI-100SS type acoustic dust cleaners installed in the convection pass of the 670 MW_{th} CFB boiler between the reheater RH2 and superheater SH3, enabled the following conclusions to be drawn:

- the root-mean-square (RMS) value of acoustic pressure generated by the acoustic cleaners was relatively high at each measurement point. However, it did not exceed a value of 150dB in any case. Considering the cubage of the convection cage, as well as the specific properties of fly ash forming as a result of brown coal combustion in the 670 MW_{th} CFB boiler, the energy of sonic waves generated by the acoustic cleaners might prove insufficient for cleaning the heated surfaces of the reheater RH2 and the superheater SH3,
- the energy of the sonic wave generated by the acoustic cleaners in the free space between the convection bundles of the reheater RH2 and the superheater SH3 is dispersed within a wide range of frequencies. The maximum sound intensity values fell to both low (100Hz and 160Hz) and high (2kHz and 3.15kHz) frequencies,
- the maximum acoustic pressure values identified in the spectral analysis of the signal generated by the acoustic cleaners were contained in the range of 120÷130 dB. This means that for the design frequency of 100 Hz the acoustic cleaners did not generate the wave of an acoustic pressure of 150 dB.

To sum up, it can be stated that the use of acoustic cleaners in the 670 MW_{th} CFB boiler's convection cage, which is characterised by a large cross-section, could bring about the desired results in the case of using devices generating a sound wave of frequencies in the range of 40÷ 100 Hz, for which the acoustic pressure level will be at least 150 dB. In the case of analysed convection cage it means that Nirafon NI-100SS type acoustic dust cleaners should be replaced by acoustic cleaners supplied with liquefied gas, for which the sound pressure level for frequency of 100 Hz exceeds an acoustic pressure of 170 dB.

REFERENCES

- Hare N., Rasul M., Moazzem S., 2010. A review on boiler deposition/fouling prevention and removal techniques for power plant. *Recent Advances in Energy and Environment. Proceedings of the 5th IASME / WSEAS International Conference on Energy & Environment (EE '10)*, 23-25 February, 2010, WSEAS press, UK. 217-222.
- Pronobis M., 2002. *Modernizacja kotłowni energetycznych*. Wydawnictwa Naukowo-Techniczne, Warszawa.
- Zbogar A., Frandsen F., Jensen P., Glarborg P., 2009. Shedding of ash deposits. *Prog. Energy Combust. Sci.*, 35, 31–56. DOI: 10.1016/j.peccs.2008.07.001.

Received 04 January 2013

Received in revised form 30 April 2013

Accepted 03 May 2013