

Idea of wheel-legged robot and its control system design

J. SZREK^{1*} and P. WÓJTOWICZ²

¹ Division of Machine Theory and Mechatronical Systems, Wrocław University of Technology,
7/9 Łukasiewicza St., 50-370 Wrocław, Poland

² Robosystem.pl Group, Aktiwa.NET, 16B Litewska St., 51-354 Wrocław, Poland

Abstract. The wheel-legged robot is a vehicle with many degrees of freedom. Thanks to its peculiar design, depending on the need, the vehicle will use one of its ways of moving: travelling on wheels or walking (in special situations), which enhances its locomotive properties. The paper presents the robot's kinematic wheel suspension system, general operation strategy and control system. The application responsible for robot control and data visualization is described. Finally, selected tests of the algorithms, carried out on the robot prototype, are presented.

Key words: wheel-legged robot, control system design.

1. Introduction

Depending on the environment in which they operate, mobile robots can be divided into several categories such as: flying robots, amphibious robots and land robots. The latter can be divided according to the way they move. There are legged robots and wheeled (including caterpillar) robots. Each of the robot designs has its merits and drawbacks. Wheeled robots are capable of higher speeds than walking robots, but the latter better perform on an uneven base.

A mobile robot with a wheel-legged suspension system combines the merits of the two designs. The robot will move on wheels on an even terrain and when it encounters an obstacle which it cannot bypass, it will surmount it by walking on it or over it.

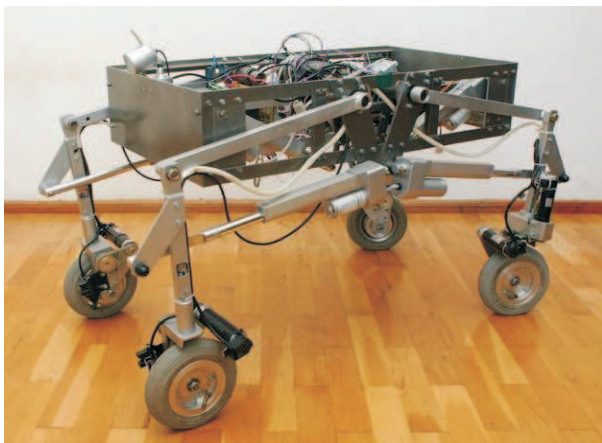

Fig. 1. Physical model of wheel-legged robot

The presented robot (Fig. 1) is a combination of a platform and four wheels guided by a special kinematic system. Each of the “limbs” ensures large movements of the wheel relative to the platform. Thanks to this the robot combines the features of a wheeled vehicle and a legged vehicle. Con-

sequently, a more universal vehicle with better locomotive properties than the ones which a legged robot has and able to walk in a terrain with obstacles is obtained.

The LegVan robot uses 14 motors – 4 travel drivers, 2 turn drivers (in rear limbs), another 4 drives (Fig. 2 – motors q_1) are responsible for horizontal position of the platform and the remaining 4 motors are used only for obstacle negotiating (motors q_2).

By changing the configuration of its limbs the robot keeps the platform level. Moreover, when it encounters an obstacle which it cannot bypass, it can walk on it or over it using the obstacle negotiating function (walking). Controlling the wheel-legged robot is a complex task. The control system has many degrees of freedom and in order to function properly a considerable number of measurement data need to be acquired and processed and the motions of many drive motors need to be synchronized. The control task in this robot has been somewhat simplified through a peculiar limb kinematic system geometry whereby the number of drives needed to keep the platform level has been reduced by four.

In paper the robot structure, suspension and control systems have been presented. Finally, selected results of the tests carried out on the robot prototype are reported.

2. Structure of wheel-legged robot

The wheel-legged robot is a mechatronic system. Its operation requires the integration of the mechanical system with the drives, the computer control system, the sensors and the software ensuring the expected robot performance. The proper combination of the components significantly affects the robot's locomotive properties.

The existing robots of this kind, e.g. Roller-Walker, Work-Partner [1] and Hylos [2], differ in the design of their mechanical system and in the way their negotiate obstacles – some raise a limb over the obstacle while other drive onto it [3]. A more detailed survey of the literature on the mechanical

*e-mail: Jaroslaw.Szrek@pwr.wroc.pl

structure and the technique of negotiating obstacles can be found in [4].

An analysis of the mechanical structures, the control systems and the general operating properties shows that the publications devote little attention to the methodology of selecting the wheel suspension design and that the wheel motion mechanisms were made without optimizing the motion characteristic and without any attempt at reducing the number of drives.

The LegVan wheel-legged robot presented here has been designed to safely and efficiently operate in uneven terrain with obstacles. The robot has a special wheel guidance (suspension) system which uses only one drive in a limb for keeping the platform level.

2.1. Wheel suspension – robot leg. One of the robot’s limbs (its general view and kinematic scheme) is shown in Fig. 2. The wheel guidance system (Fig. 2b) has two DOFs and it is based on four-bar linkage ABCD modified by replacing rocker CD with variable-length link q_2 (a servomotor). The wheel is mounted on coupler BC (Fig. 2b does not show the steering knuckle needed to execute a turn). The other link (whose length is variable) – servomotor q_1 – forces a proper position of rocker AB.

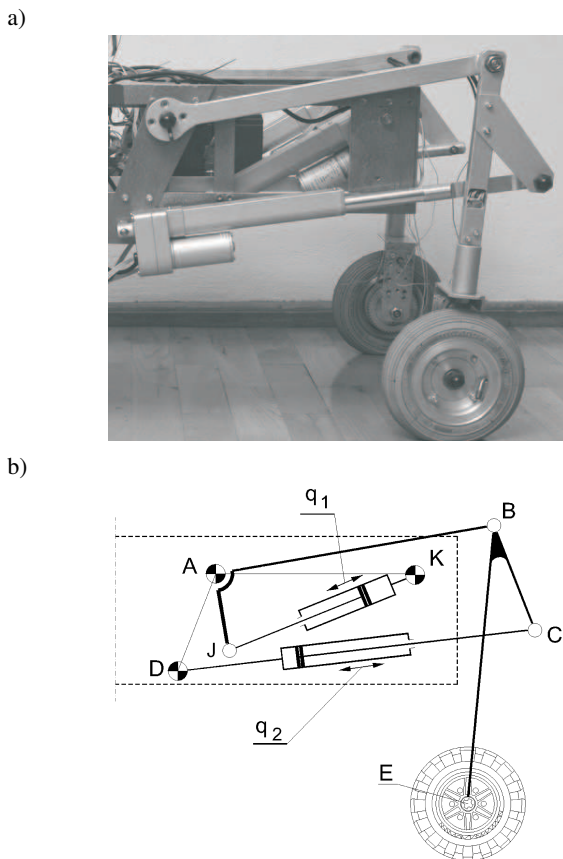

Fig. 2. Robot’s limb: a – general view, b – kinematic scheme

This structure of the wheel suspension system makes it possible to level the platform by steering with only one drive q_1 . For this purpose the geometry of four-bar linkage ABCD (the dimensions of its members) should be so designed that

within a certain range of motion at constant length q_2 the centre of the wheel (a point on link BC) will move along trajectory μ similar to a straight line segment. A method of geometric synthesis of such a system can be found in [5, 6]. The dimensions of the links were determined for the assumed length of trajectory μ and the corresponding angular displacement of rocker arm AB. It was also assumed that a linear characteristic of wheel centre displacement versus angular displacement of rocker AB will be obtained.

Thanks to its peculiar geometry the obtained kinematic system ensures that the robot’s basic function – keeping the platform level – is performed using only one drive (q_1). The other drive (q_2) is then a link whose length is constant – the rocker arm of the four-bar linkage. Walking or getting over an obstacle requires that the wheel centre be guided along a specific curvilinear trajectory, which necessitates the control of the motion of both drives: q_1 and q_2 .

3. Robot’s functions

During its operation the robot moves on wheels executing the trajectory assigned by the user or an external planning system and keeping the platform level. Levelling can be executed autonomously through changes in the robot posture depending on the terrain unevenness measured by the inclinometers located on the platform.

The robot’s additional function is obstacle negotiating (walking). Thanks to its peculiar suspension when the robot encounters an obstacle (e.g. a threshold, a kerb), it can surmount it by walking on it or over it. The obstacle is located by sensors situated in front of the robot’s wheels.

A robot stability analysis should be carried out before the obstacle negotiating function can be used. When a step is taken (the wheel raised), one of the points of support is lost whereby the stability area is reduced. For this reason the robot has been equipped with a system measuring the pressures exerted by the wheels onto the base. Receiving these data the robot by changing the position of the centre of mass and that of the points of contact of the wheels with the base (e.g. by moving the limbs) can have an influence on its stability and safe operation.

The general idea of the robot operation is based on the behavioural controller concept. Having received a task to be performed (a motion trajectory), the robot begins to carry it out. On the basis of the data coming from the level sensors and the obstacle detection system, the robot autonomously adjusts its posture to the uneven terrain and surmounts the obstacles encountered on its way to the destination. When an obstacle on robot’s way will appear the procedure of obstacle negotiating will run. The each procedures has been created as a software module which has been selected depending on actual occurrence.

Moreover, during the operation of the robot all the parameters are being visualized and recorded whereby the functioning of the individual systems can be later analyzed and any faults detected. From the data one can also draw conclusions about the effectiveness of the algorithms.

4. Control system

The robot has one central control computer and several local autonomous controllers. The central computer is located on the robot and it wirelessly communicates with a remote control computer (the user). The local systems are responsible for the execution of the desired robot motions and for taking all the measurements.

The central computer receives (via the wireless connection) a request for executing a specific motion. Subsequently, it sends the proper parameters to the local controllers responsible for the motion of the appropriate motors. Taking measurements and executing the motions the local controllers carry out the task. A diagram of the control system is shown in Fig. 3.

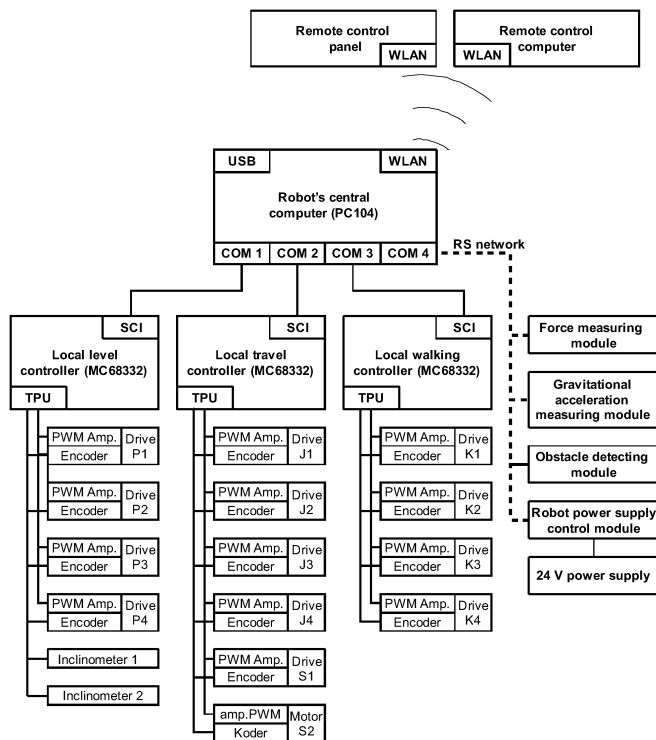

Fig. 3. Structure of robot control system

An industrial computer (PC 104) was used as the robot's central computer. The unit, based on the LX800 processor with reduced power consumption, constitutes a small autonomous computer with sufficient computing power and wireless WLAN transmission. The computer has four RS232 serial communication ports which are used for communication with the local modules. The (master-slave) communication in the robot is fully controlled by the robot's central computer. Having sent a request to an appropriate module the central computer receives a specific amount of data (measurement data, an acknowledgement that motion parameters have been accepted, etc.) depending on the instruction sent.

Three of the subordinate microcontrollers (connected to three different ports) are responsible for the motions of the drive motors. Receiving the assigned position (the position, walking and turn drives) and speed values (the drive of the

robot wheels) they locally attain the assigned values using the PID controller. The control takes place within the microcontroller with the position value feedback coming from the coders mounted on the axles of the motors. The motor voltage is adjusted through changes in pulse-width modulation. The full position-speed controller is based on a module with an MC68332 microcontroller [7].

Besides setting the assigned robot parameters, the local modules on request send back the current positions, motor speeds and the deviation of the platform from the horizontal (the inclinometers).

The other modules, network coupled and connected to one serial port, are mainly responsible for performing measurements. One of them measures the gravitational acceleration components whose values are used, for example, to set the inclinometers to zero.

Another microcontroller measures the pressures exerted by the limbs on the base. The measuring system was designed to fit into the robot's limb. The tensiometric measuring system keeps supplying data to the central control computer. The information about the pressures exerted by the robot's limbs on the base is particularly critical when the robot switches to the walking mode and raises one of its limbs. Then one of the points of support is lost which may lead to the loss of stability. Having the information about the pressures the robot can react properly to counteract any stability loss.

The last module subordinate to the central computer is the robot power supply system. Depending on the received command, this system powers up/down the individual robot blocks. Moreover, information about the obstacles which appear in front of the robot's wheels get to the central computer via this module.

There is also a camera (connected to the USB port) mounted on the robot, transmitting the picture of the robot's surroundings to the operator and so supplementing the information about the encountered obstacles.

5. Robot's application layer

The software is responsible for the functioning of the whole system and it should fit the structure of the control system shown in Fig. 3. The hierarchy shown in Fig. 4 has been adopted in the wheel-legged robot.

The above diagram shows the particular components (modules and software) of the controller and the flow of information.

One of the blocks comprises low-level software. These are procedures and algorithms stored in the memory of the local modules carrying out the tasks assigned to them (adjustment, measurements). Each of the local modules is individually programmed to respond to the requests from the central computer. In the hierarchy shown in Fig. 4 the considered block is situated at its bottom. It directly affects the surroundings through the execution of robot motions.

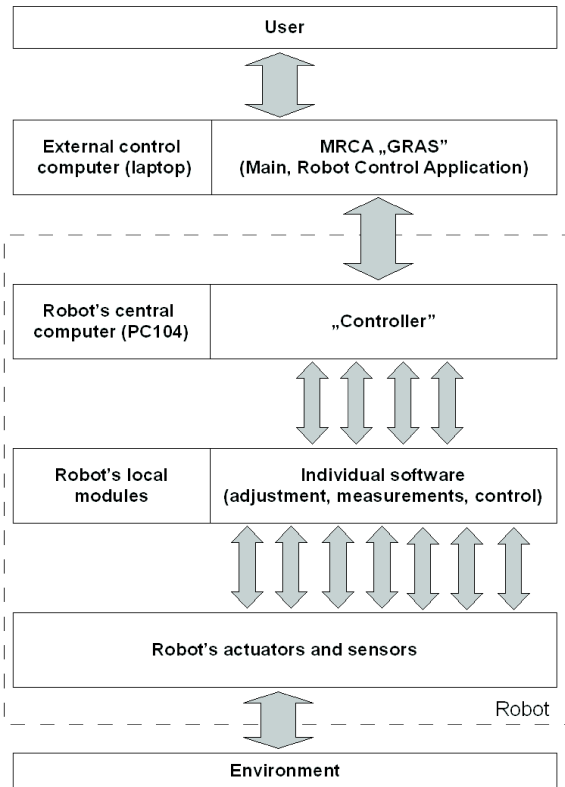

Fig. 4. Hierarchical structure of control system

Another application (but of a higher order) is the “Controller”. The program is run on the robot’s central control computer and it is responsible for data exchange (through the serial ports) with the local modules. It periodically communicates with the particular robot modules, sending requests and reading the current parameters. The data received from the modules are made available through a network connection and transmitted to other applications.

Another application used for controlling the robot is MRCA (Main, Robot Control Application). Its task is to exchange data with the “Controller” application (and so with the local controllers), visualize the robot parameters, interpret the data from the manual control panel, display the picture from the camera mounted on the robot and, above all, to implement the robot operation strategy. MRCA can be run on the robot’s central computer or on the remote control computer (or on another computer having a network connection with the robot).

The robot can be controlled in three ways: from the manual control panel (robot motion), through the automatic realization of the stored algorithm and through the realization of the algorithm from the script control module.

The script control module allows one to create control algorithms without program compilation whereby one can easily and quickly modify the robot operation algorithms, which is particularly useful at the stage of prototype launching and makes it possible to plan the robot motion without interfering in the complicated code of the MRCA program. Having test-

ed an algorithm in the script module one can create (through compilation) individual procedures executing the particular tasks. The main, robot control commands can be issued in two ways: via the manual control panel or from an external trajectory planning system.

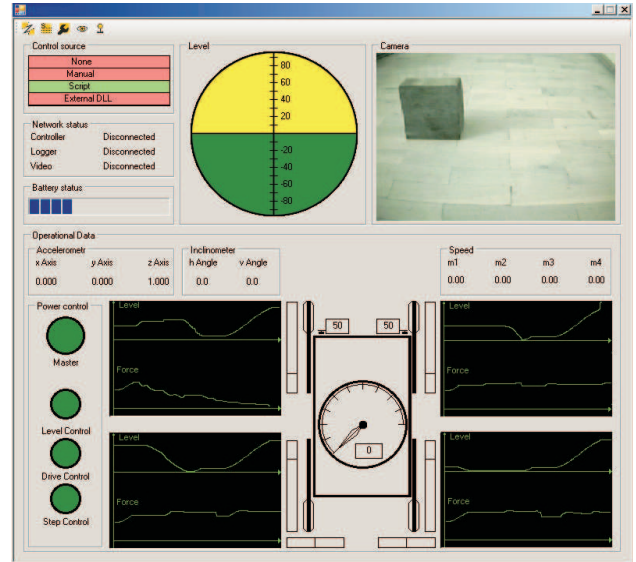

Fig. 5. Main window of MRCA and external control computer

The external planning system, using the same way of transmitting data as the manual panel, can independently control the robot. A computer joystick, connected to the remote control computer, is used for manual control. It has several buttons and two analogue positioners and is highly suitable for the control function.

6. Experimental tests

The models and algorithms and the actual robot were experimentally verified [8]. But prior to that the control system and its particular components had been designed, built and tested. As regards software, the control system design allows for easy composing of algorithms. The experimental results are presented in the form photographs and selected parameter traces recorded during the operation of the robot. Consequently, the particular dependencies can be visualized and the algorithm performance can be analyzed.

Idea of wheel-legged robot and its control system design

The wheel-legged robot has been designed mainly to operate in an uneven terrain and to be able to overpass obstacles by walking.

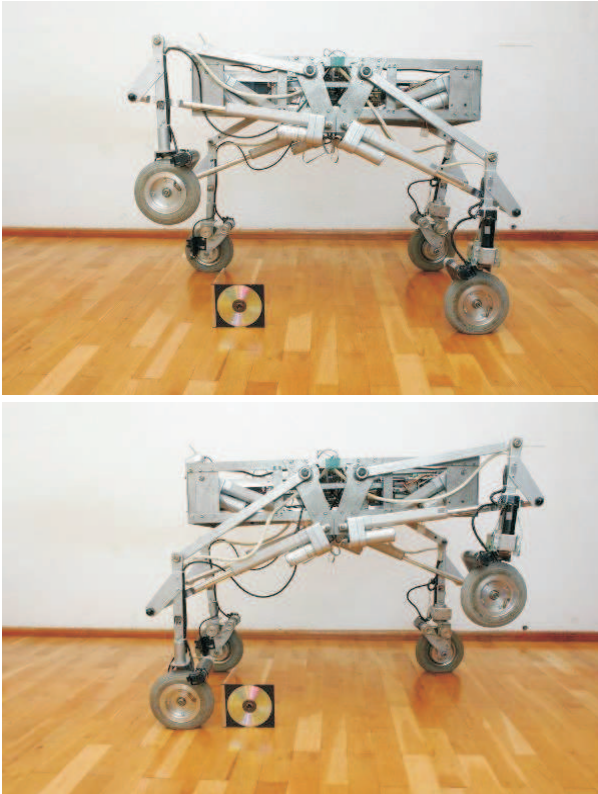

Fig. 6. Robot's motion capabilities

Figure 6 shows the robot's motion capabilities – the raising of respectively the front and rear limb. The photograph includes an item (a typical CD) which is to show the scale of robot movements. The robot's two primary functions – obstacle negotiating and levelling – were mainly tested during the experiments.

At the current stage, the operation of the levelling algorithm is based on a proportional controller with an added condition dividing the command signal among the front and rear levelling servomotors. The algorithm works as follows:

1. if the measured deviation from the horizontal $> \pm e$ (a specific value closed to zero – experimentally assigned), specify the drives and the direction of motion reducing deviation e ;
2. if $e > 0$, lower the front limbs, raise the rear limbs;
if $e < 0$, raise the front limbs, lower the rear limbs;
3. if a pair of drives reached the extreme position, execute motion with the opposite pair (changing the direction);
4. if the deviation from the horizontal $< e$, stop the levelling motion, return to 1.

The obstacle negotiating function is performed by executing sequences of stored steps, which depend on the parameters (distance from the obstacle, high of the obstacle, the pres-

sure exerted by the limbs on the base, etc.) coming from the system's sensors.

6.1. Testing of obstacle negotiating function. For the analysis it was assumed that an obstacle can be situated in front of one wheel or two wheels. These two cases will differ in the way in which the obstacle is negotiated and so in the operation algorithm.

The particular stages in the negotiation of an obstacle located in front of one of the wheels are shown in Fig. 7 while Fig. 8 shows selected data recorded during the experiment. The obstacle situated in front of one wheel is negotiated autonomously and the elevation to which the limb is to be raised is determined by the robot on the basis of the obstacle's height. In this case, the course of the process can be examined by tracing the elevation of the robot's left limbs, the distance of the wheel from the obstacle and the motion velocity. The graphs illustrate the process which proceeds as described below.

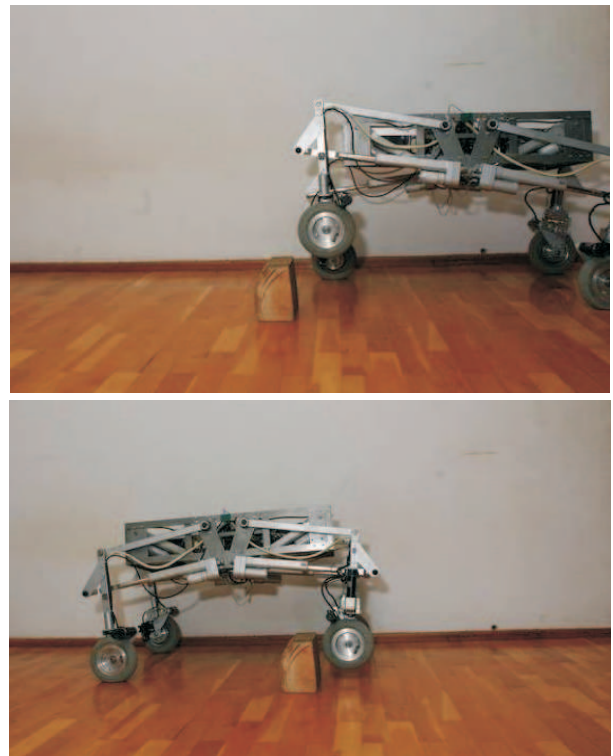

Fig. 7. Obstacle negotiating function – obstacle in front of one limb

The robot moves executing the assigned trajectory (rectilinear in this case). At some moment the sensors located in front of one of the robot's wheels (the left one) give information that an obstacle is being approached (Fig. 8, point A). The speed is reduced (point B) and when the robot comes within 15 mm from the obstacle, it is stopped (point C).

Then the robot gets ready to raise (change the distance of the wheel axle from the platform's bottom edge) the limb which is in front of the obstacle. In order to ensure its stability, it lowers the opposite rear limb until a specific (experimentally predetermined) pressure is attained.

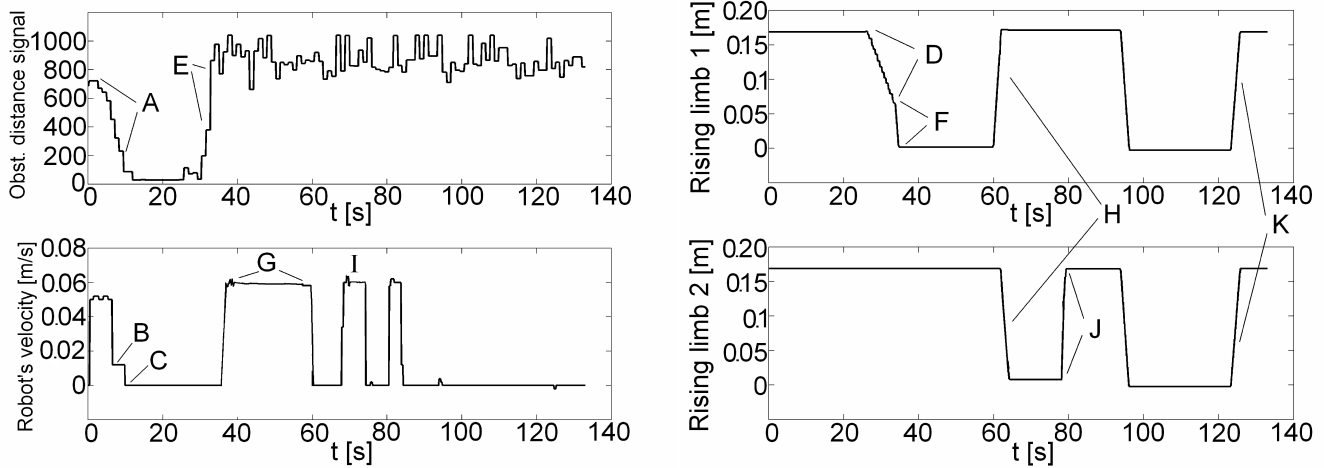

Fig. 8. Obstacle negotiating experiment measurement data

The limb is raised above the obstacle (point D) at a slower speed until the obstacle's edge is located by the distance sensor. A sharp increase in distance from the obstacle means that the sensor has been brought above the obstacle's edge (point E).

The limb is further raised (faster) in order to bring the wheel to point F above the obstacle. With the limb raised the robot drives over the obstacle until the rear wheel finds itself in front of the obstacle (the travelled distance is equal to the distance between the front and rear wheels).

When the rear wheel finds itself in front of the obstacle, the front limb is lowered and the rear one is raised (point H). Now the robot has only to drive with its rear limb raised (point I) and lower it onto the base (point J). Having negotiated the obstacle, the robot continues on its way, after a while it stops and lowers the platform (point K). Currently, the robot is equipped with sensors which can determine obstacle height, but the other dimensions (length) are not known.

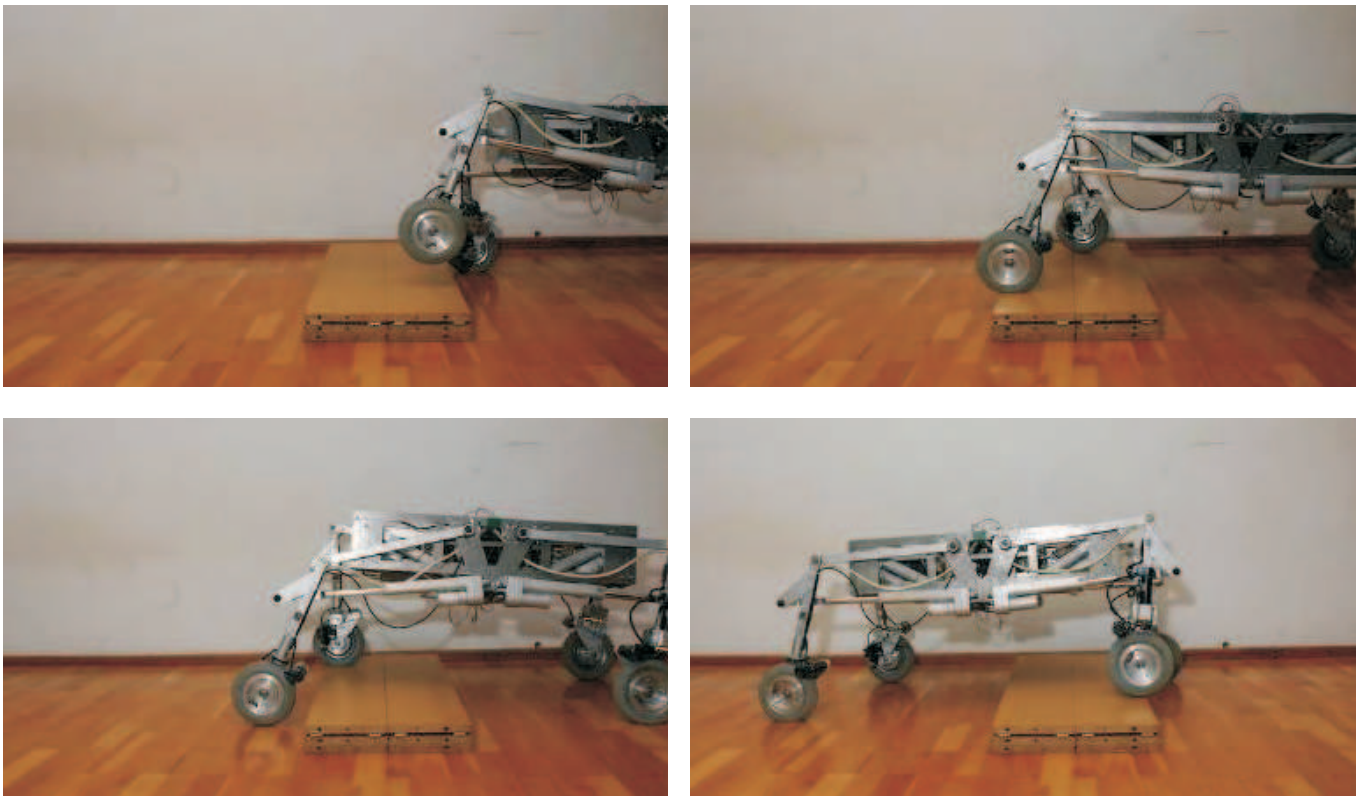

Fig. 9. Obstacle negotiating function – obstacle in front of robot

6.2. Testing of levelling function. The levelling function was tested on the obstacle course shown in Fig. 10. Several robot runs at different speeds and levelling algorithm parameters were carried out. A robot run with the levelling function turned off was carried out for comparison. The runs started from the same place and for the same robot start configuration (platform elevation).

The experiment starts when the robot is in front of the obstacle course and the platform is maximally lowered (0.26 m from the base, zero limb elevation). The modules are powered

up, the robot lifts the platform by 0.145 m and starts on its way.

Figure 11 shows experimental traces for robot speed $v = 0.02$ m/s. Figure 11a shows the trace for the robot run with the levelling function turned off. The deflection of the level sensor (inclinometer) changes with the inclination of the obstacle course. The graphs in Fig. 11b illustrate the operation of the levelling function. This time the deviation of the platform from the horizontal fluctuates around zero while the elevation of the front and rear limbs changes.

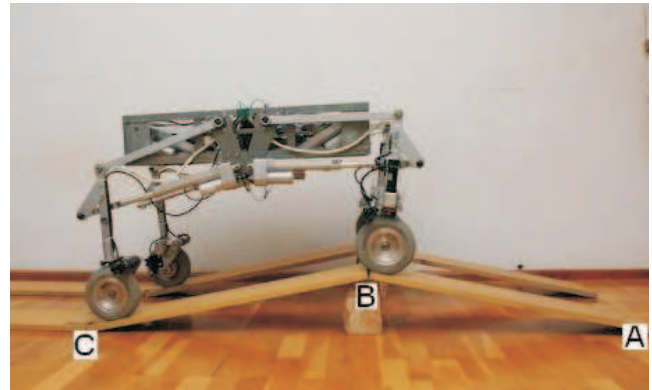

Fig. 10. Obstacle course for robot and robot during experiment

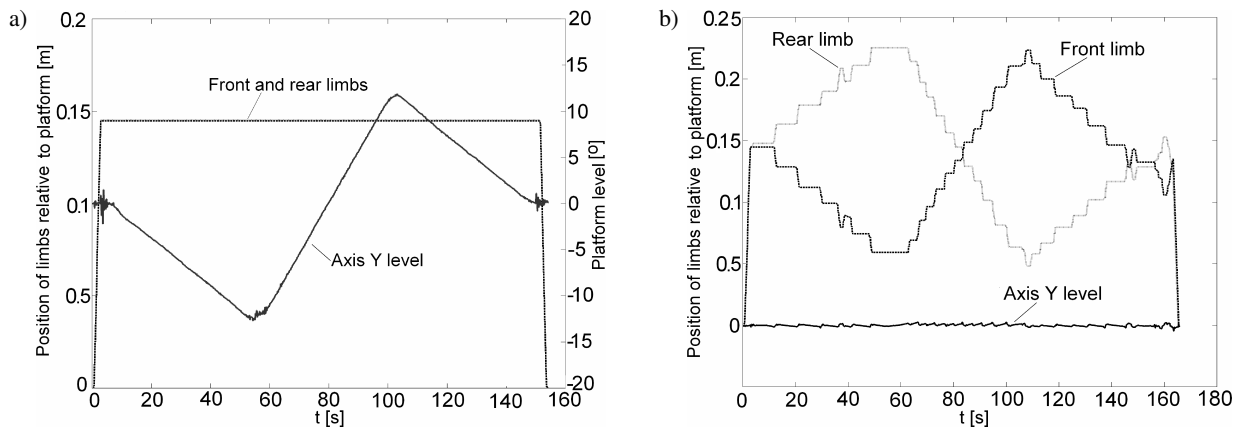

Fig. 11. Measurement data from levelling function tests – levelling off (a), levelling on (b)

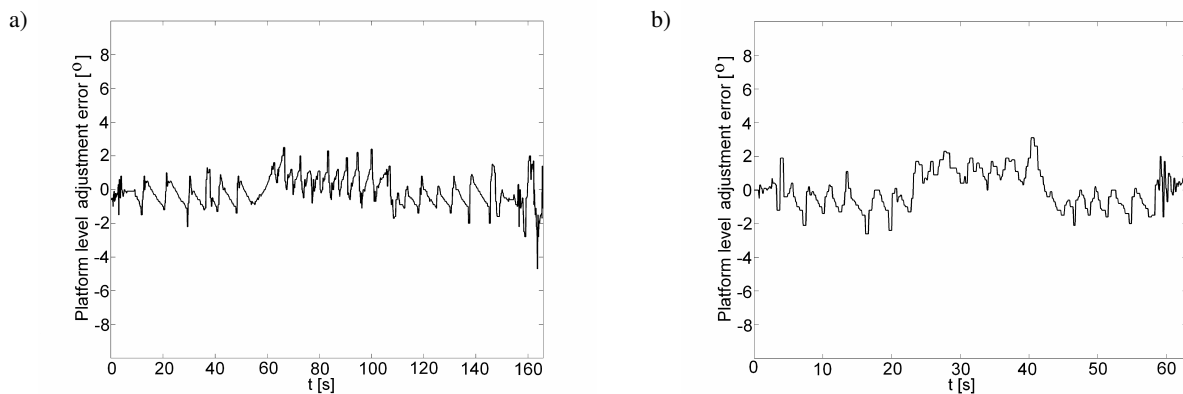

Fig. 12. Trace of platform levelling error at robot speed of 0.02 m/s (a) and 0.05 m/s (b)

The platform levelling error is shown in Fig. 12. The maximum deviation of the platform from the horizontal amounts to 2° at a speed of 0.02 m/s and to 3° at a higher speed of 0.05 m/s.

7. Conclusions

The design and construction of the wheel-legged robot with a complete control, communication and diagnosis system is the first step in research on such robots. The LegVan wheel-legged robot with an autonomous levelling and obstacle detection system makes further multifaceted research possible. The presented experimental studies have proved the adopted mechanical structure and control system solutions to be correct.

This peculiar robot design makes it possible to test wheeled robot control algorithms and to develop algorithms for wheel-legged robots. When the robot is equipped with a more advanced vision system, it will be possible to test obstacle detection systems in different environments.

The research can also be aimed at a novel suspension system for the robot's wheels, which will significantly improve the mobility of the robot in a terrain with obstacles. The adopted dimensions of the robot, particularly those of its

limbs, allow the robot to walk on stairs, which is also to be investigated.

REFERENCES

- [1] A. Halme, I. Leppänen, S. Salmi, and S. Ylönen, "Hybrid locomotion of wheel-legged machine", *Proc. CLAWAR 2000 Conf. Professional Engineering Publishing Ltd.* 1, 167–173 (2000).
- [2] Ch. Grand, F. BenAmar, F. Plumet, Ph. Bidaud, "Stability control of a wheel-legged mini-rover", *Proc. CLAWAR 2002 Conf. Professional Engineering Publishing Ltd.* 1, 323–330 (2002).
- [3] S. Guccione and G. Muscato, "The wheeleg robot", *IEEE Robotics & Automation Magazine* 10 (4), 33–43 (2003).
- [4] J. Szrek, "Hybrid suspension systems of mobile robots", *8th Scientific Seminar of Students and Young Mechanical Engineers* 1, 363–369 (2005).
- [5] J. Szrek, "Method of synthesizing mobile wheel-legged robot", *20th Research-Educational Conf. Theory of Machines* 1, 207–213 (2006).
- [6] J. Szrek, *Synthesis of the Kinematic and Control System of a Quadruped Wheel-legged Robot*, PhD thesis, Wrocław University of Technology, Wrocław, 2008.
- [7] M. Wnuk, "Module with MC68332 microcontroller", in: *Report SPR 7/2004*, Wrocław University of Technology, Wrocław, 2004.
- [8] <http://robosystem.pl> – website with robot's presentation film.