

Surface acoustic wave hydrogen gas sensor based on layered structure of palladium/metal-free phthalocyanine

W.P. JAKUBIK*, M. URBAŃCZYK, E. MACIAK, and T. PUSTELNY

Institute of Physics, Silesian University of Technology
2 Krzywoustego St., 44-100 Gliwice, Poland

Abstract. A layered sensor structure of metal-free phthalocyanine H₂Pc (~160 nm) with a very thin film of palladium (Pd~20 nm) on the top, has been studied for hydrogen gas-sensing application at relatively low temperatures of about 30°C and about 40°C. The layered structure was obtained by vacuum deposition (first the phthalocyanine Pc and then the Pd film) onto a LiNbO₃ Y-cut Z-propagating substrate, making use of the Surface Acoustic Wave method, and additionally (in this same technological processes) onto a glass substrate with a planar microelectrode array for simultaneous monitoring of the planar resistance of the layered structure. In such a layered structure we can detect hydrogen in a medium concentration range (from 0.5 to 3% in air) even at about 30°C. At elevated temperature up to about 40°C the differential frequency increases proportionally (almost linearly) to the hydrogen concentration and the response reaches its steady state very quickly. The response times are about 18 s at the lowest 0.5% hydrogen concentration to about 42 s at 4% (defined as reaching 100% of the steady state). In the case of the investigated layered structure a very good correlation has been observed between the two utilized methods – the frequency changes in the SAW method correlate quite well with the decreases of the layered structure resistance.

Key words: layered structure, metal-free phthalocyanine, palladium, hydrogen gas sensor, surface acoustic wave.

1. Introduction

Monitoring the composition of atmospheric gases is the most important requirement for personal protection and environmental monitoring. The results of dangerous gas concentrations are usually needed immediately, with a low false-alarm tolerance, high sensitivity and minimum cost. Surface Acoustic Wave (SAW) gas sensors with a specific layered sensor structure, although clearly not perfect, offer the potential to approach those goals.

Surface Acoustic Wave (SAW) gas sensors are very attractive because of their remarkable sensitivity due to changes of the boundary conditions of the propagating wave, introduced by the interaction of an active layered structure with specific gas molecules. This unusual sensitivity results from the simple fact that most of the wave energy is concentrated near the crystal surface within one or several wavelengths. Consequently, the surface wave is in its first approximation highly sensitive to any change of the physical or chemical properties of the thin active sensor structure previously placed on a crystal surface. As long as the thickness of the sensor structure is substantially less than the wavelength of the surface wave, we can speak of a perturbation of the Rayleigh wave (in our case the whole thickness of the layered sensor structure $h \sim 100$ nm and $\lambda = 80$ μ m). Otherwise, we have to take into account other types of waves, such as Love waves, which can propagate in layered structures [1].

A very interesting feature of the SAW sensors is the fact that the layered sensor structure (as semiconductor and metal) on a piezoelectric substrate provides new possibilities of detecting gas in a SAW sensor system by using an acoustoelectric coupling between the surface wave and the sensor structure in a high sensitivity interaction region [1–4]. In such a layered sensor structure we can use acoustoelectric interactions in the SAW sensor system as the main detection mechanism. This effect can be many times greater than the commonly used mass effect which is dominant in nonconductive polymer films and simple metal and dielectric films in SAW gas systems [5, 6]. In order to take full advantage of the high sensitivity offered by the SAW sensor through the acoustoelectric effect, the entire conductivity of the sensor structure must be contained in some particular range. We are in the position (by creating a thin palladium layer on the phthalocyanine film) to place the “work point” of such structures in a high sensitivity region, where even small changes in conductivity cause great changes of the velocity of the surface wave and consequently of the frequency.

Thus, the sensitivity of such a layered structure can be incredibly high, as schematically explained in Fig. 1. The “work point” of such a structure must be shifted to the high sensitivity region “B”, where small variations in conductivity (under the influence of gas molecules) cause remarkable changes in the wave velocity. Thus, to take full advantage of the high sensitivity offered by the SAW sensor, the conductivity of the sensing film must be tailored to a particular range.

*e-mail: wjakubik@polsl.pl

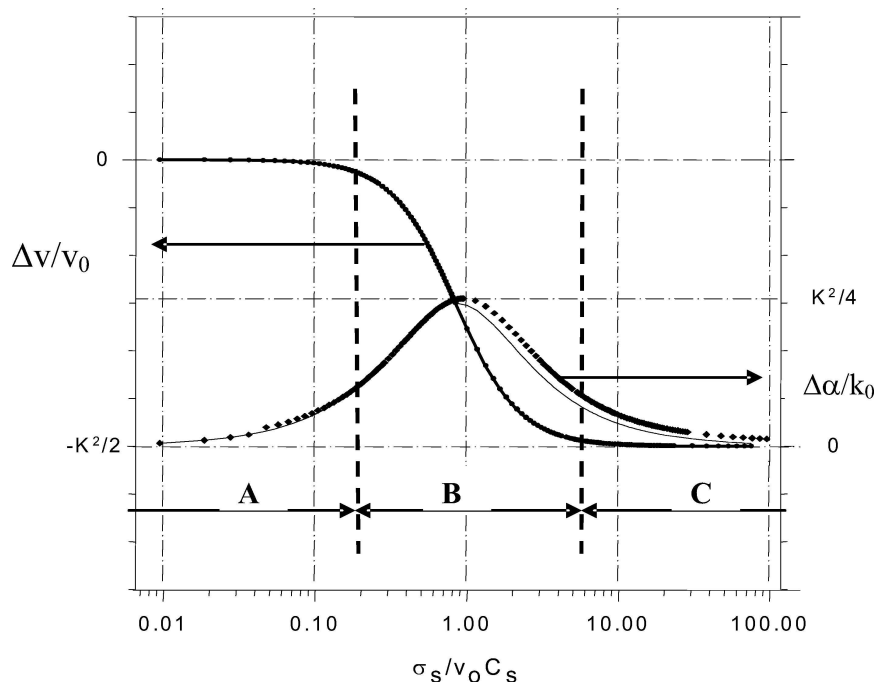

Fig. 1. Theoretical dependence of relative changes of the SAW velocity (left axis) and attenuation (right axis) vs. the normalised surface conductivity σ_s where $\sigma_s = v_0 C_s = 1.6 \times 10^{-6} [\Omega^{-1}]$ for LiNbO_3 Y-Z (v_0 is unperturbed SAW velocity, C_s is the sum of the piezoelectric substrate and environment permittivities). A – region with a single phthalocyanine (Pc) layer, B – region with a layered structure, C – region with a single metal film

We have examined several layered structures of this type (metallophthalocyanine + palladium) for the detection of hydrogen [7, 8]. The best are structures with metal-free and copper phthalocyanines and palladium on the top. The structures with metal-free phthalocyanines and palladium display the greatest changes in frequency at various hydrogen concentrations. However, the responses of structures with copper phthalocyanine and palladium seem to be faster but display smaller frequency shifts [9]. Thus, we decided to carry out more precise investigations of the structure with metal-free phthalocyanine and palladium from the point of view of hydrogen detection. Three such structures with various thicknesses of metal-free phthalocyanine (120 nm, 160 nm and 200 nm) and the same thickness of the palladium film (20nm) at relatively low interaction temperatures 30–40°C have been examined [7–9]. The almost optimized structure seems to be as follows: about 160 nm H_2Pc (metal-free phthalocyanine) and about 20 nm Pd (palladium). This structure provides the best responses to the investigated hydrogen concentrations (from 0.5% to the explosive limit 4%) in dry air and at low interaction temperatures of about 40°C. In this paper the characteristics of this optimized layered sensor structures are investigated more precisely towards medium hydrogen concentrations.

2. Experimental setup

The idea and the photos of the layered sensor structure on the piezoelectric substrate in the SAW and electric systems are shown in Fig. 2.

On a piezoelectric LiNbO_3 substrate (Y cut Z propagation, 20 mm wide, 30 mm long and 2 mm thick) two identical

acoustic paths are formed by interdigital transducers. These transducers consist of 20 finger pairs, each 20 μm wide and 20 μm away from the adjacent finger. The operating frequency of each delay line is about 43.6 MHz and the wavelength 80 μm . The interdigital transducers are 14 mm apart from each other. Next, an active sensor structure is formed in the measuring line by two different vacuum deposition processes. The whole experimental set-up is based on frequency changes in an acoustic surface wave dual delay line system, which is well known [10–12]. The second path serves as a reference and can compensate small variations of temperature and pressure. Both delay lines are placed in the feedback loop of oscillator circuits and the response to the particular gas of the active bilayer is detected as a change of the differential frequency Δf , i.e. the difference between the two oscillator frequencies f and f_0 . In the electronic circuits we used amplifiers of the type $\mu\text{A} 733$, and the supplied voltages were usually between 5 and 6 V. Additionally, changes in the electrical resistance of a sample with the same structure made in the same technological process as the SAW device, have been measured. Details concerning this simple electrical planar method are described in literature [7, 12].

The investigated sensor structure was obtained by means of the vacuum sublimation method, using a special aluminium mask. Before the specific process of sublimation, the piezoelectric substrate was chemically cleaned (in various chemical solvents) in a special way and H_2Pc powder (Aldrich) was initially degassed at 200°C for 15 to 20 min in vacuum (10^{-4} Torr). The H_2Pc vapour source consisted of a crucible placed in a properly formed tungsten spiral. A copper-constantan thermocouple was used to control the temperature.

Surface acoustic wave hydrogen gas sensor based on layered structure of palladium/metal-free phthalocyanine

The thin (20 nm) palladium layer was formed separately by means of vapour deposition in high vacuum and after the deposition of a phthalocyanine film in a new process. The thicknesses of the films were monitored by means of the QCMB method with an accuracy of 0.5 nm for Pd and 1nm for the phthalocyanine film. The thickness of the whole sensor structure is considerably less than the wavelength of the surface acoustic wave, which is 80 μm . In such a case we can still take into account the disturbance of the Rayleigh surface wave on the piezoelectric substrate.

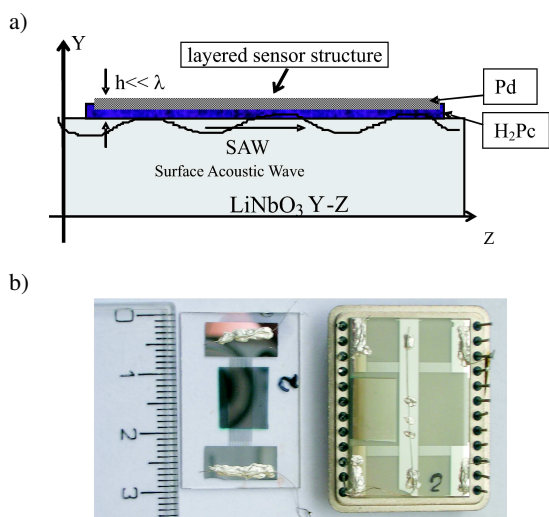

Fig. 2. (a) The layered structure of the sensor consists of two layers produced in two different vapor deposition processes. The thickness of the sensor material, h , is considerably less than the wavelength, λ , of the SAW, (b) the photos of the investigated layered structure with metal-free phthalocyanine and palladium thin films – SAW method (right) and electric planar method (left)

placed. Besides – the Data Acquisition Switch Unit Agilent 3497 A for measuring the temperature and the resistance and Frequency Counter Agilent 53181 A. The gas flow control system ensures the dosing of the gases to the measuring chamber. The total flow rate of 500 ml/min was used in all measurements. All results are collected in PC through the GPIB interface.

3. Results

In all measurements considerable repeatable changes of the differential frequency Δf were to be observed. As the hydrogen sensor should finally work in an atmosphere of air, the measurements were first carried out in synthetic dry air with various medium hydrogen concentrations from 0.5% to 4%.

An example of the result for the investigated structure 160 nm H_2Pc + 20 nm Pd, obtained in a dry-air atmosphere and a cycle of hydrogen concentrations at about 25°C, is shown in Fig. 4. In the case of the first concentrations (0.5%, 1% and 1.5%) a rather small interaction is obtained. The differential frequency slightly increases with a maximum of about 250 Hz for 1.5% hydrogen concentration, but the response reaches its steady state very quickly. For this range of hydrogen concentrations the Pd film is in an α crystal phase. For this Pd phase the hydrogen absorption is faster than for the second phase β [13].

At a 2% and higher hydrogen concentrations, however, the interaction is larger – about 0.5 kHz frequency shift. A greater decrease of the Δf frequency is obtained, which can be interpreted as a change in the crystal phase from α to β . The steady-state is not reached, however, as fast as in the α phase. Additionally, the electrical resistance of the sample was also monitored. At higher hydrogen concentrations, the resistance decreases correlating quite well with acoustic measurements. This correlation can be interpreted in the category of acoustoelectric interactions [7–9].

The result concerning this same layered structure 160 nm H_2Pc + 20 nm Pd, obtained in a dry-air atmosphere and a cycle of hydrogen concentrations but at elevated temperature to about 40–43°C is shown in Fig. 5. The differential frequency increases proportionally (almost linearly) to the hydrogen concentration and the response reaches its steady state very quickly – about 18 s at lowest 0.5% hydrogen concentration to about 42 s at 4% (defined as reaching 100% of the steady state). The change of the differential frequency defined as $\delta(\Delta f) = \Delta f(\text{hydrogen}) - \Delta f(\text{air})$, versus the investigated hydrogen concentration in dry air is shown in Fig. 6.

A great increase of the Δf frequency is obtained, which can be interpreted as a change in the crystal phase from α to β . The electrical resistance of the sample was not monitored this time.

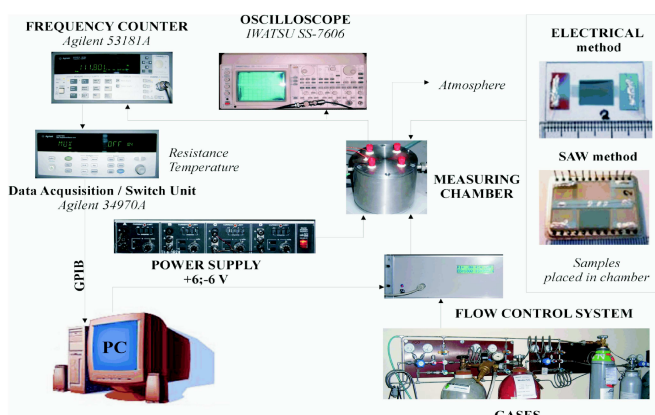

Fig. 3. Schematic diagram of the experimental set-up

The schematic diagram of the whole experimental set up is shown in Fig. 3. The main part is the measuring chamber, where samples for both SAW and electrical methods are

W.P. Jakubik, M. Urbańczyk, E. Maciak, and T. Pustelny

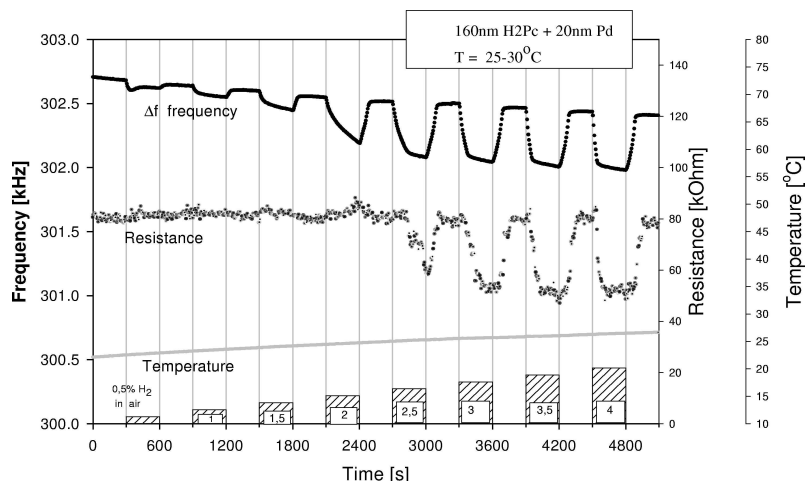

Fig. 4. Interaction in synthetic dry air of a layered structure 160 nm H₂Pc + 20 nm Pd, at various hydrogen concentrations (from 0.5% to 4%) and at a temperature of about 25–30°C

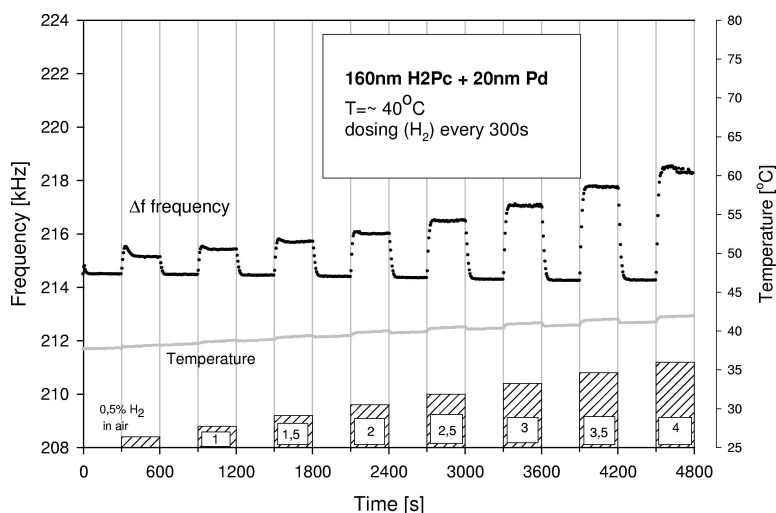

Fig. 5. Interaction in synthetic dry air of a layered structure 160 nm H₂Pc + 20 nm Pd, at various hydrogen concentrations (from 0.5% to 4%) and at a temperature of about 40–43°C

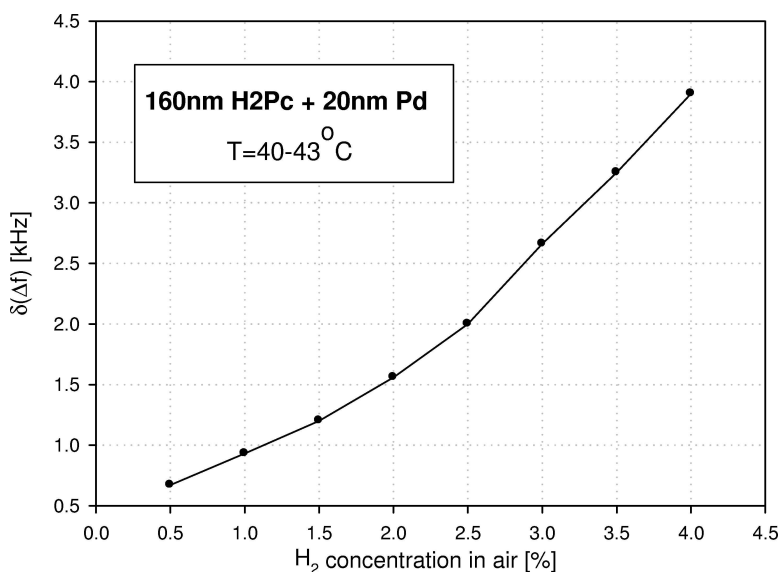

Fig. 6. The change of the differential frequency defined as $\delta(\Delta f) = \Delta f(\text{hydrogen}) - \Delta f(\text{air})$, versus investigated hydrogen concentration in dry air

4. Discussion

A simple interaction model of a layered structure (phthalocyanine and palladium) with hydrogen molecules is shown in Fig. 7. The described physical and chemical base of hydrogen molecules adsorption on palladium was proposed first by Lundstroem long ago [14]. In the case of a layered structure of the Pd+Pc type the base is similar, although the absorption of atomic hydrogen to the volume of phthalocyanine film is also possible.

Molecular hydrogen dissociates to atomic hydrogen on the outer palladium surface, then the atomic hydrogen diffuses into the palladium film and some of it is adsorbed at the inner palladium surface. Adsorbed hydrogen atoms then act as electrical dipoles at the metal-semiconductor interface and create alterations in the work function of palladium at the interface and in the surface conductivity of the phthalocyanine layer. These variations in the surface conductivity can cause considerable changes in the velocity of the acoustic surface wave, which finally leads to a modification of the measuring frequency and differential frequency Δf as well.

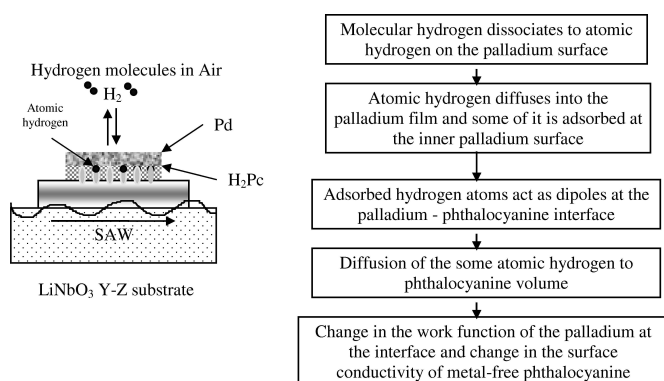

Fig. 7. Physical and chemical basis of the function of a layered sensor structure

5. Conclusions

Hydrogen molecules can be detected in the layered sensor structure: metal-free phthalocyanine and palladium, in a surface acoustic wave system with a specific thickness of the layers. In such a layered structure we can detect hydrogen in a medium concentration range (from 0.5 to 4% in air) even at about 25–30°C. At elevated temperature to about 40–43°C the differential frequency increases proportionally (almost linearly) to the hydrogen concentration and the response reaches its steady state very quickly. Simultaneously, the response and regeneration times are on the level of several seconds, which is very important from the practical point of view of the detection of highly explosive hydrogen gas.

Changes in the SAW velocity are possible in the case of surface conductivity variations only when the resulting conductivity of the layered structure is properly fitted to the active range of the acoustoelectric effect. This active range depends

mainly on the velocity of the substrate SAW and the dielectric properties of the substrate and environment. The layered structures with various materials in the SAW sensor system seem to be very promising in hydrogen detection [15, 16]. It seems that further researches will be focused on the proper fitting of the entire sensor structure to the high sensitivity region for a given piezoelectric substrate, and on the proper construction of the electronic system in order to excite a surface wave.

Acknowledgements. The work is financed by the grant No: PW-004/ITE/02/2006.

REFERENCES

- [1] W.P. Jakubik, M.W. Urbańczyk, S. Kochowski, and J. Bodzenta, "Bilayer structure for hydrogen detection in a surface acoustic wave sensor system", *Sens. Actuators, B. Chem* 82, 265–271 (2002).
- [2] W.P. Jakubik, M. Urbańczyk, S. Kochowski, and J. Bodzenta, "Palladium and phthalocyanine bilayer films for hydrogen detection in surface acoustic wave sensor system", *Sens. Actuators, B. Chem* 96, 321–328 (2003).
- [3] J.D. Galipeau, L.J. Le Gore, K. Snow, J.J. Caron, J.F. Vetelino, and J.C. Andle, "The integration of a chemiresistive film overlay with a surface acoustic wave microsensor", *Sens. Actuators, B. Chem* 35–36, 158–163 (1996).
- [4] W. Jakubik, M. Urbańczyk, and E. Maciak, "SAW bilayer gas sensor structure with a polyethylene membrane", *XX Eurosensors* 1, 124–125 (2006).
- [5] D'Amico, A. Palma, and E. Verona "Hydrogen sensor using palladium coated surface acoustic wave delay-line", *IEEE Ultrason. Symp.* 1, 308–311 (1982).
- [6] A. Venema, E. Nieuwkoop, M.J. Vellekoop, W. Ghijsen, A. Barendsz, and M.S. Nieuwenhuizen, "NO₂ gas-concentration measurement with a SAW-chemosensor", *IEEE Transaction on Ultrasonics, Ferroelectrics and Frequency Control* UFFC-34 (2), 148–155 (1987).
- [7] W. Jakubik, "Sensor properties of bilayer structures with palladium, lead and cobalt phthalocyanines in surface acoustic wave and electric systems", *Molecular and Quantum Acoustics* 25, 141–152 (2004).
- [8] W. Jakubik and M. Urbańczyk, "Hydrogen detection in surface acoustic wave gas sensor based on interaction speed", *Proc. IEEE Sensors 2004 Third International Conf. Sensors* 11, 1514–1517 (2004).
- [9] W. Jakubik, "Investigations of bilayer sensor structure with copper phthalocyanine and palladium for hydrogen detection in SAW system", *J. de Physique IV* 137, 95–98 (2006).
- [10] W. Jakubik, M. Urbańczyk, and A. Opilski, "Sensor properties of lead phthalocyanine in a surface acoustic wave system", *Ultrasonics* 39, 227–232 (2001).
- [11] M. von Schickfus, R. Stanze., T. Kammereck, D. Weiskat, and W. Dittrich, "Improving the SAW gas sensor: device, electronics and sensor layer", *Sens. Actuators, B. Chem* 18–19, 443–447 (1994).
- [12] O. Varghese, D. Gong, W. Dreschel, K. Ong, and C. Grimes, "Ammonia detection using nanoporous alumina resistive and surface acoustic wave sensors", *Sens. Actuators, B. Chem* 94, 27–35 (2003).
- [13] M. Tabib-Azar, B. Sutapun, R. Petrick, and A. Kazemi, "Highly sensitive hydrogen sensors using palladium coated fiber op-

W.P. Jakubik, M. Urbańczyk, E. Maciak, and T. Pustelny

- tics with exposed cores and evanescent field interactions, *Sens. Actuators, B Chem* 56, 158–163 (1999).
- [14] I. Lundström, M. Shivaraman, and Ch. Svensson, “A hydrogen-sensitive Pd-gate MOS transistor”, *J. Appl. Phys.* 46, 3876–3881 (1975).
- [15] S. Ippolito, S. Kandasamy, K. Kalantar-zadeh, A. Trinchi, and W. Wlodarski, “A layered surface acoustic wave ZnO/LiTaO₃ structure with a WO₃ selective layer for hydrogen sensing”, *Sensor Letters* 1, 33–36 (2003).
- [16] S. Ippolito, S. Kandasamy, K. Kalantar-zadeh, and W. Wlodarski, “Layered SAW hydrogen sensor with modified tungsten trioxide selective layer”, *Sens. Actuators, B. Chem* 108, 553–557 (2005).