

*RIZA GÜRBÜZ**

CONTROLLING FLOW RATE AND FLUID LEVEL BY VARIABLE FREQUENCY DRIVE UNIT

The Variable Frequency Drive (VFD) is used to control the speed of the pump-motor to attain the desired flow rate and fluid level in a fluid system. An AC drive provides efficient flow control by varying the pump-motor speed. The comparison of energy requirements and costs in a system where a throttling device is used for flow control on a centrifugal pump with the power used when an variable frequency drive (VFD) is used to control the same flow, evidently shows potential savings. In this system, AC Motor Frequency drive and static pressure transmitter, turbine type flowmeter and Analog/Digital cards, micro-control unit and computer connection are designed specially to control flow rate, fluid flow type (turbulence or laminar) and water level at the different conditions with different PID parameters.

1. Introduction

1.1. Energy efficiency with motor speed control

Energy efficiency is basically related with motor speed control. Approximately sixty percent of all electrical energy is used in applications of flow loads, such as pumps, fans, blowers and compressors, mostly powered by constant speed A.C. electrical motors. When output flow requirements fluctuate in such systems, an external means of adjustment is needed. Commonly used methods for flow control include throttling or restrictive devices such as valves, outlet dampers, inlet vanes and diffusers. Mechanical speed changers and recirculating systems are also sometimes used. However, all these devices waste energy, dissipate power by friction and diffuse heat.

Fixed-speed pumps are used nearly full available electrical energy and consume nearly maximum energy full time, regardless of demand. Power re-

* Çankiri Karatekin University Technical and Business College, Turkey; E-mail: rizagurbuz@karatekin.edu.tr

quirements for throttled systems drop only slightly even when flow or volume is reduced significantly.

Variable speed devices such as belt transmissions, gears, magnetic clutches and hydraulic drives accomplish this function mechanically, but they are costly, bulky, waste power and require high maintenance.

Variable frequency control of AC induction motors with mechatronics control devices such as pressure transmitters, flow meters, data acquisition cards and proper software programme provides an economically sound and operationally effective solution for speed control and reduced power consumption.

They can also be made receptive to signals from flow sensors, pressure transmitter, programmable controllers and other control systems. Micro controller or computer based AC motor control affords users options that can provide short- and long-term productivity and profitability improvements.

Using a variable frequency drive in a pumping system provides additional savings, because many elements required in a valve-controlled system are eliminated or reduced without affecting the function.

Losses in a valve-controlled system occur in the valve and in the additional piping required to bring the valve to a location where it can be adjusted. With the variable frequency drive, there is no valve or valve losses. With no pipe bends required for the valve, the piping losses are also reduced. With the elimination of the pipe and valve losses, a smaller pump can often be used. Users can achieve the same results-flow rates and pressure- with a lower power pump.

Significant system cost savings are realized providing additional economic justification for using a variable frequency drive. Moreover, microprocessor-based variable frequency drives can perform functions previously handled by programmable controllers, microcontrollers or computer controlled improving process flexibility and further eliminating components and cost [1].

1.2. Closed-loop PID control for measurement of liquid level in the industry

Continuous processes have been controlled by feedback loops since the late 1700s. The Taylor Instrument company implemented the first fully functional proportional Integral and Derivative (PID) controller in 1940 [2].

PID controllers are used to control a wide range of process quantities. A typical application is a closed-loop level control for water tank. With this application, the water level (PID set point) must be kept constant in the water tank, irrespectively of the amount of water that flows into the tank. This means that the speed of the pump must be adapted according to the

quantity of the water that flows into the water tank, which is detected using a filling level sensor (PID actual value) [3].

Control operation block diagram of water level control system is shown in Figure 1. Flow turbine meter (Pulse) and pressure transmitter (4-20 mA) sends regular signals to computer through Analog/Digital Cards. Computer also send the information to the variable frequency drive of pump motors to keep the water level at the programmed level. This process continues until the water level approaches the programmed level.

A pressure transmitter is used to determine the liquid level in a tank, well, river or other body of liquid. The pressure at the bottom of a liquid-filled container is directly related to the height of the liquid. Hydrostatic head pressure of water in the cylinder is measured by pressure transmitter and this pressure value is changed to liquid level as meter in the computer programme. To get an accurate reading, the pressure transmitter should be located at the lowest point where measurement is required; typically it is mounted or laying on the bottom of the tank (see Fig. 4).

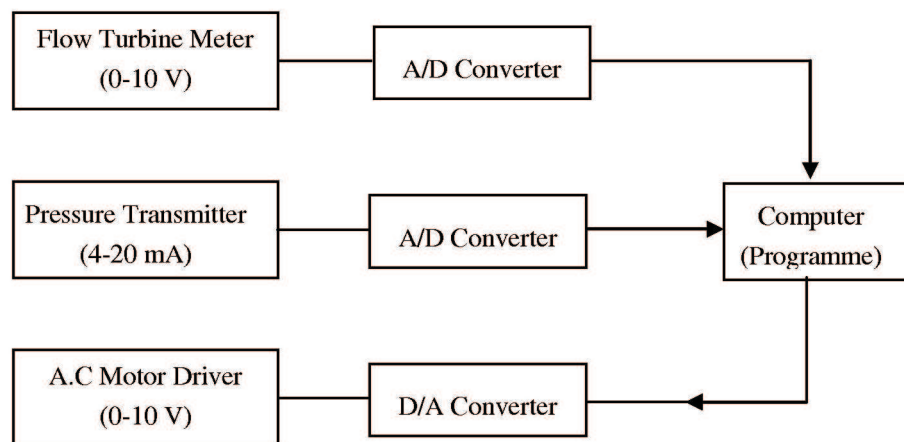

Fig. 1. Control Operation Block Diagram

2. Specification of water level measurement device and the results of experimental analysis

2.1. Specifications of water level measurement device

Water level measurement device was specially designed to allow a detailed study on water level measurement by means of a computer. The water flows from the pump through a turbine-type flow meter into water tank. It

travels approximately 2 meters through the pipes. A pressure transmitter, A.C. Motor driver, turbine type flow meter and 4 data acquisition cards have been used to measure and to control the water level by the computer.

The A.C. motor-speed controlled water-level device is shown in Fig. 1 and Fig. 2. The photos of the pressure transmitter and the Analog/Digital cards and their power supply are shown in Fig. 3 and Fig. 4. The measurement of the height of water level, whose result depends on static pressure of the water cylinder and flow velocity in the pipe, is used to determine the flow type (turbulent or laminar). All that information is transferred through the data cards (4-20 mA, 0-10 Volt) to an I/O port of the computer to control the system.[4].

It is necessary to utilize a proper software in order to perform a number of calculations required for optimizing the water level measurement systems in a reasonable period of time. The values of many of these parameters can change and influence the overall system performance. Thus, the use of computer makes it possible to analyze the parameters very quickly, and to display the measured and calculated values on the computer screen. The Analog-to-Digital, and the Digital-to-Analogue cards are used to convert the analog signals into digital signals, and vice versa, in the computerized systems.



Fig. 2. Photo of water-level measurement device

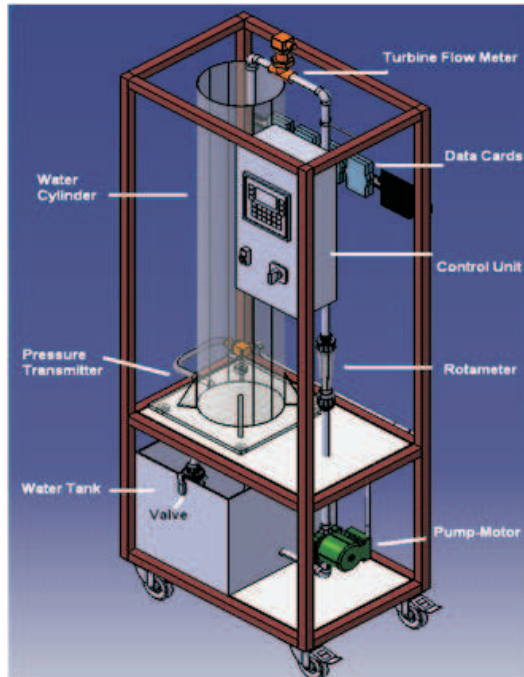

Fig. 3. Schematic diagram of device



Fig. 4. Photo of pressure transmitter and valve

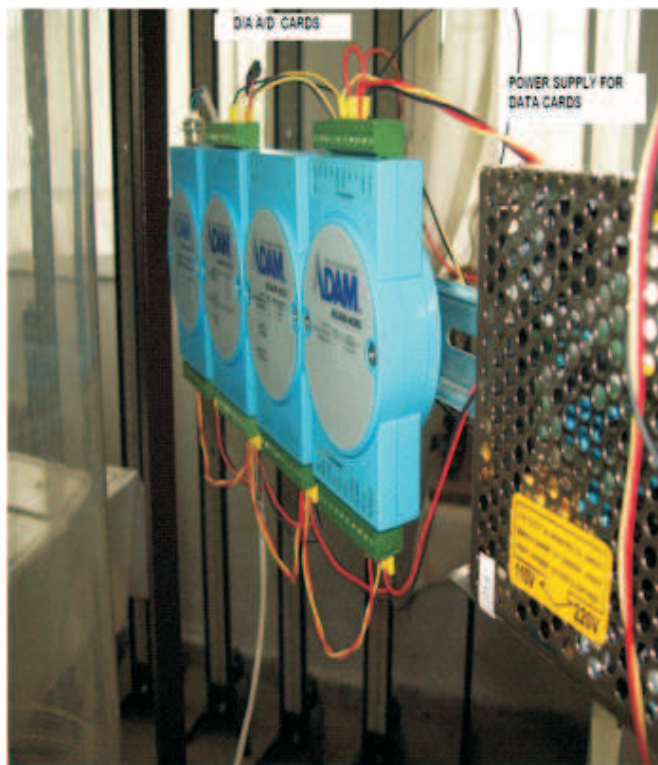

Fig. 5. Photo of D/A and A/D cards and power supply

2.2. Results of experimental analysis at the different flow rates and PID parameters

In the computer controlled experiment, the flow-rate valve in the returning line was opened to a quarter, a half, three quarter and a full throttle. The water level, the PID output parameters were arranged before the experiment.

Whenever the pump starts running, the computer should be started to record the data by pressed the play button. Using the data acquisition cards, it measures the data corresponding to the flow rate, velocity of water the in pipe, Reynolds number, flow type, water level and pressure on the bottom of water cylinder. The data can be received in determined programmed intervals. Table 1, contains the input data, the measured and calculated data and the applied equations. Figures 6,7,8,9,10,11 present the time courses of the obtained water levels [4].

The data and equations shown in Table 1 were used to develop the software for this system.

Table 1.

Measured and calculated data

Input data	Measured and calculated data	Used equations
Fluid Type : Water Density (ρ) : 1000 kg/m ³ Specific gravity (g) : 9.81 m/s ² Viscosity (μ) : 0,001 Pa.s Pipe Inside Diameter (d) : 21 mm Water Temperature (θ) : (10°C) (for viscosity value in table)	Velocity (U) : m/s Flow Rate (\dot{V}) : m ³ /s, L/s Reynold Number (Re) :	$U = \dot{V} / A$ $A = \prod d^2/4$ $Re = d U \rho/\mu$

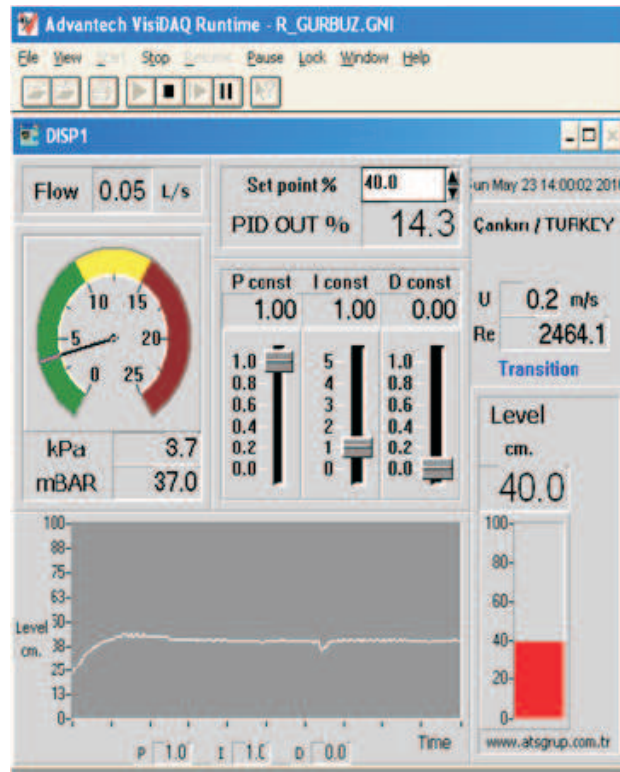

Fig. 6. Tank valve 3/4 closed, P=1, I=1

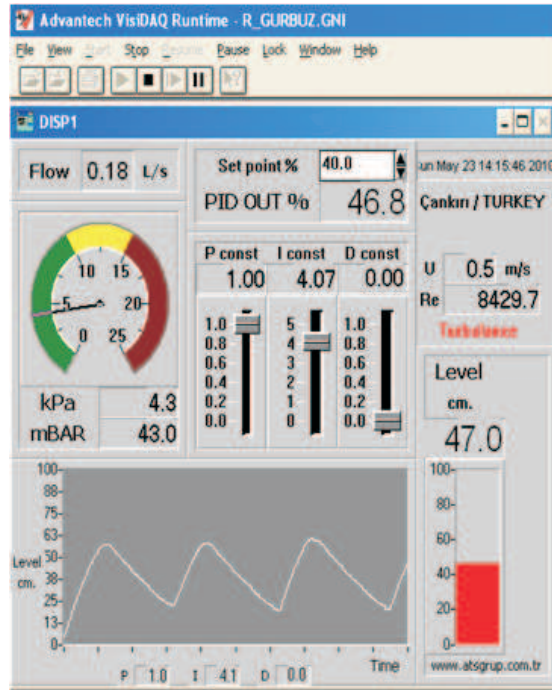

Fig. 7. Tank valve 3/4 closed ,P=1, I=4

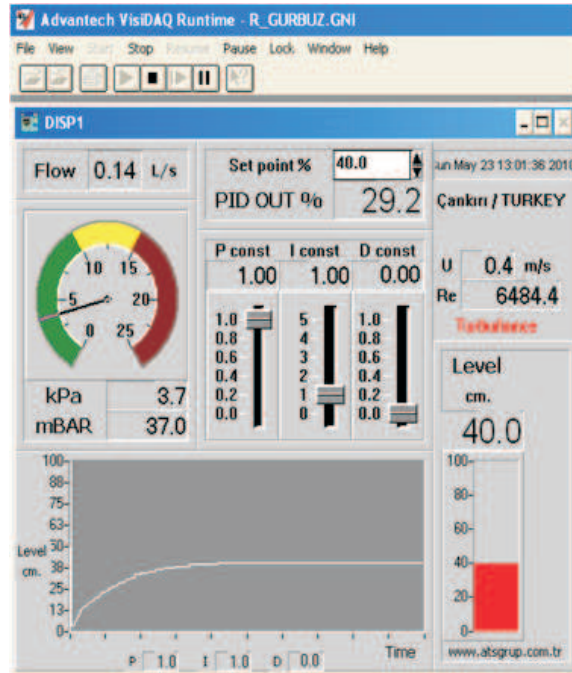

Fig. 8. Tank valve 1/2 closed, P=1, I =1

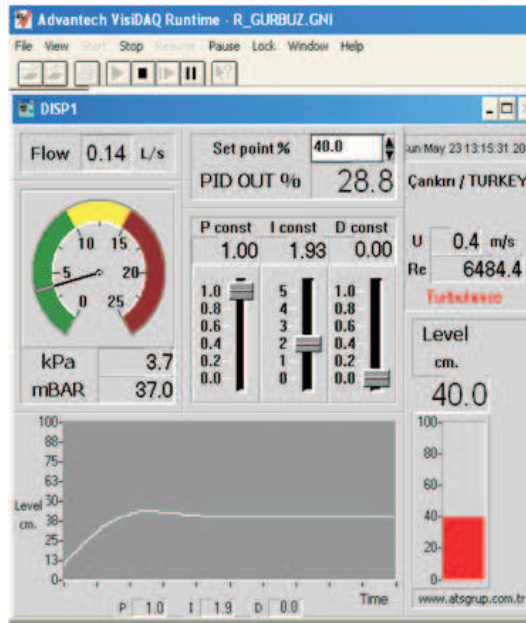

Fig. 9. Tank valve 1/2 closed, P = 1, I = 2

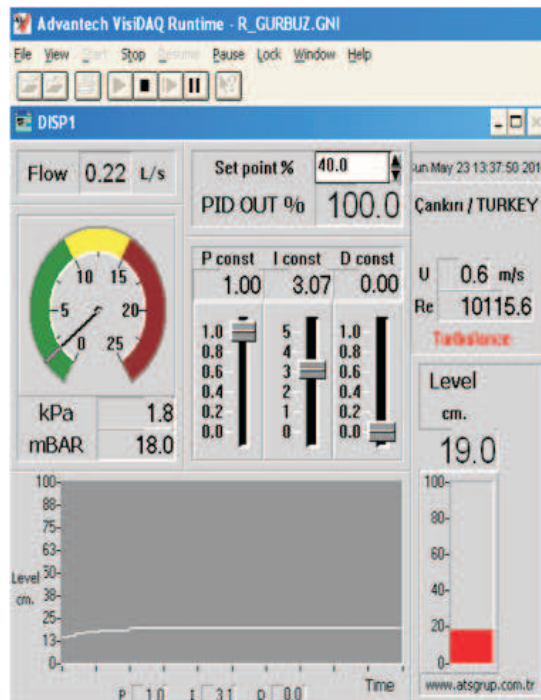

Fig. 10. Tank valve fully opened, P=1, I=3

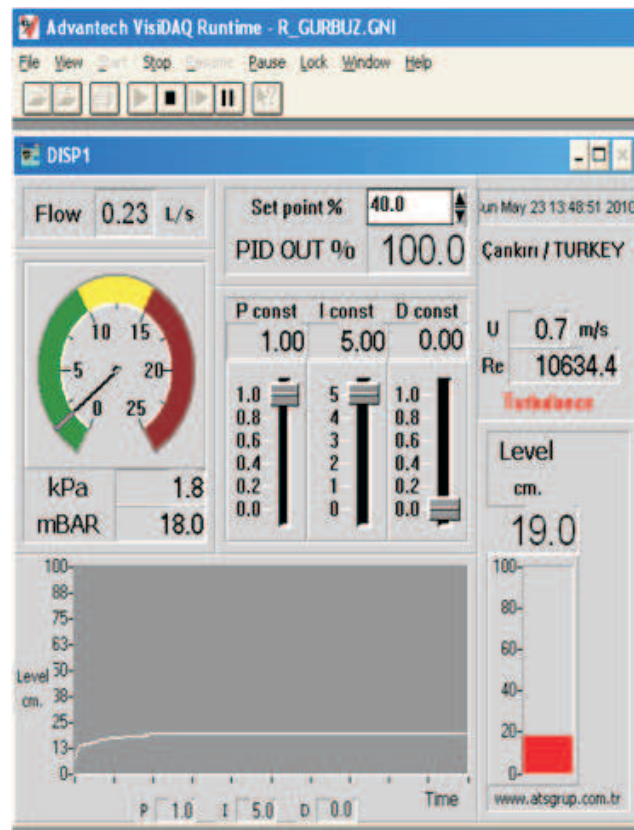

Fig. 11. Tank valve fully opened, $P = 1$, $I = 5$

3. Summary and conclusion

A water-level system can be controlled in two ways in the closed-loop system. The first method consists in applying a microcontroller, the second one is controlling by means of a computer. In the above-presented system, both two methods were used, to compare them. A special switch was designed to change the control unit from one method of operation to another. Using the user interface on the computer screen, it was possible to set the gain values of the Proportional, Integral and Derivative control, adjusting all of them or only one value, to follow the changing conditions in the system [2].

The proportional term is the simplest of the three methods (PID) and is also the most commonly encountered control technique in feedback systems. The amount of correction applied to the system is directly proportional to the error. As the gain increases, the applied correction to the system becomes more aggressive. This type of controller is common for reducing the error to

a small, but non-zero value, leaving a steady error. In the experiments, the valve in the retuning line to water tank (Figure 4) was either fully closed, or opened to a half, and three quarter and a full throttle.

Unlike the proportional control, the integral method takes into account the steady errors. Given this, the accumulated error is used to calculate the integral term in fixed time intervals. Basically, every time the fixed interval ends, the current error at this moment is added to the error variable [2].

The proportional term works on the present error, the integral term works on the past error to forecast a future response of the system.

Three different experiments have been realized in this system.

1. First one: The valve in the returning line is 3/4 closed, two different P and I values applied (Figs. 6 and 7).

When I values increases from 1 to 4, the system response of water level is getting worse. The water level rises to 40 cm height (adjusted level) in approximately 3 minutes.

2. Second one: The valve in the returning line is 1/2 closed. two different P and I values applied (Fig. 8 and 9).

In experimental analysis of this system, the gain factor of the proportional control unit is equal to 1, and I value is increasing from 1 to 2. There is no significant differences between the two values. Water level is rising to 40 cm in approximately 1 minute.

3. Third one,: The valve in the returning line is fully opened, two different P and I values are used (Fig. 10 and 11).

The pump power (flow rate is 0,22 l/s) was not sufficient to arrange the water height balance between water cylinder and water tank Therefore, the water level does not arise to 40 cm in the water cylinder. The maximum height reaches 19 cm in two different conditions and different P I parameters. The graphs showing results of the two experiments are similar.

This means that the pump power is not sufficient to reach the assumed water level. Changing P,I,D values are not effected on the maximum water height during the process. It is possible to make many experiements by changing PID parameters to find out ideal working conditions.

Manuscript received by Editorial Board, October 11, 2010

REFERENCES

- [1] TORY K.: "Pump Control with Variable Frequency Drives" Pumps & System, June 2008 <http://www.pump-zone.com>.
- [2] VALENTI C.: "Implementing a PID Controller Using a PIC18 MCU" Microchip Technology 2004, AN937, <http://ww1.microchip.com>.
- [3] 465 "PID Filling Level Control with Bumpless Operating Mode Changeover" Siemens Drive Technology Micromaster N:11, <https://www.swe.siemens.com>.

- [4] GURBUZ R.: "Measuring Local Losses in Pipe Flows Utilizing Data Acquisition Card and a Computer" UICEE World Transactions on Engineering and Technology Education, Volume 2, Number 3, 2003, p. 461.

Sterowanie prędkością przepływu i poziomem płynu za pomocą zespołu napędowego o zmiennej częstotliwości

S t r e s z c z e n i e

Napęd o zmiennej częstotliwości (VFD) jest stosowany do sterowania szybkością silnika pompy w celu utrzymania pożądanego poziomu płynu w systemach zawierających płyny. Napęd z silnikiem prądu zmiennego zapewnia bardziej efektywne sterowanie przepływem przez zmianę prędkości obrotowej silnika pompy. Potencjalne oszczędności stają się oczywiste gdy porówna się wymagania energetyczne (moc) i koszty w systemie gdzie do sterowania przepływem jest używany zawór dławiący na pompie odśrodkowej, do podobnych parametrów sterowania tym samym przepływem za pomocą napędu o zmiennej częstotliwości. W omawianym systemie zastosowano napęd z silnikiem prądu zmiennego o regulowanej częstotliwości, statyczny przetwornik ciśnienia, przepływomierz typu turbinowego oraz przetworniki analogowo-cyfrowe i zespół mikrosterowania współpracujący z komputerem, które zapewniają kontrolę szybkości przepływu, typu przepływu płynu (turbulentny lub laminarny) i poziomowi wody w różnych warunkach.