

SURROUND 3-DIMENSIONAL SCANNER

Krzysztof Karbowski

Cracow University of Technology, Institute of Production Engineering, Poland

Corresponding author:

Krzysztof Karbowski

Cracow University of Technology

Institute of Production Engineering

al. Jana Pawła II nr 37, 31-864 Kraków, Poland

phone: (+48) 12 628-32-47

e-mail: karbowski@mech.pk.edu.pl

Received: 26 February 2016
Accepted: 20 February 2017

ABSTRACT

The paper describes original 3-dimensional structured light scanner used for medical application. Scanner kinematics is similar to the gantry mechanism of computed tomography apparatus. The unique feature of the presented scanner is a glass table for capturing image of a human body part. The scanner can acquire an object through the table. It gives the chance for surround scanning of the human body, using only one scanning head, without changing the body position. It is more cost effective scanner solution than multihead scanner configuration.

KEYWORDS

human body, surround scanning.

Introduction

Since the beginning of the XXth century, a significant progress occurred in field of non-contact gathering of information about three-dimensional geometry. Simultaneously, there has been an increase in accessibility and number of applications of practically all the 3D scanning methods – from laser point and slit scanners, through photogrammetry and multi-camera systems, to structured light systems. In the mechanical engineering industry, the 3D scanning is widely used for inspection and reverse engineering [1, 2].

Three-dimensional models of objects are also used for training simulations in scope of virtual and augmented reality technologies [3]. In the case of inanimate, static objects, the 3D scanning brings satisfactory results [1]. In the case of medical applications or will for use of scanning for creation of more ergonomic products, adjusted to anthropometric features of a given human, there is a number of challenges, in form of impossibility of non-uniform lighting of a scanned body part and change of its shape and position during the measurement [4]. For example, 3D scan of a human hand is difficult to obtain for a few reasons:

- using the rotation tables generates the instinctive movements of a human body (Figs. 1 and 2),
- scanning by handheld 3D scanners is time-consuming and it causes unintentional body movements (Fig. 3),
- scanning of a hand in classical 3D scanner requires vertical position of a forearm or rotating of a hand.

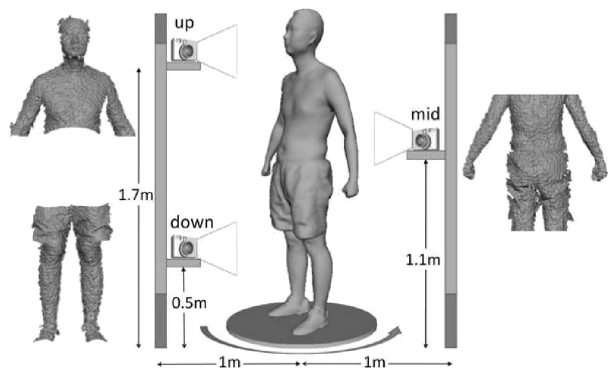

Fig. 1. Scanning of whole human body [5].

In literature, a number of examples of devices designed directly for facilitation of obtaining of anthropometric data can be found.



Fig. 2. Rotating table [6].



Fig. 3. Handheld 3D scanner [7].

Massen [8] has presented the structured light 3D scanner with rotary camera in relation to the body part. Markers applied on the surface of the objects were used to assemble the scans.

Kahlon [9] has described the 3D structured light scanner for reconstructing of the human feet. The scanned objects has been placed on the glass plate.

Similar 3D scanner has been shown by Huang and Yu [10]. The glass plate has been used as a table for the human foot.

Tohme [11] is the inventor of structured lights scanner with rotary head.

Rodríguez-Quinónez et al. [12] describe 3D Medical Laser Scanner which is based on a novel principle of dynamic triangulation. Presented scanner has been used for the optical monitoring of scoliosis (Fig. 4).

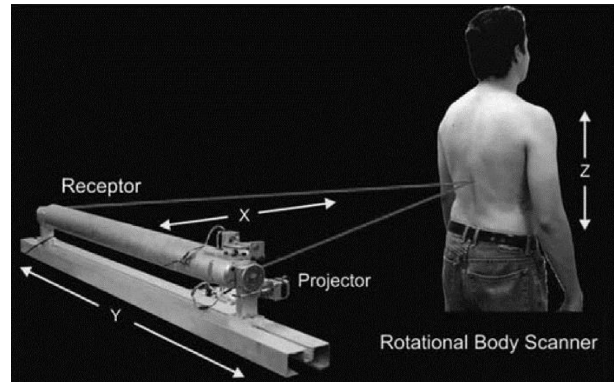

Fig. 4. 3D Medical laser Scanner [12].

Vorum company [13] offers handheld laser 3D scanner for prosthetics applications (Fig. 5).

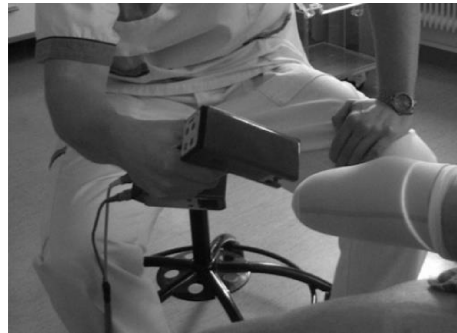

Fig. 5. 3D Prosthetics and Orthotics Scanner [13].

Another way of scanning of the human body is shown by Liu et al. [14]. They propose a novel application that automatically reconstructs a real 3D moving human captured by multiple RGB-D cameras in the form of a polygonal mesh (Fig. 6).



Fig. 6. Human body reconstruction via multiple low-cost depth cameras [14].

Similar problem has been presented by Pesce et al. [15]. The scanning equipment has been constructed from eight low cost digital cameras Canon Power Shot A480 and four white light lamps (Fig. 7).

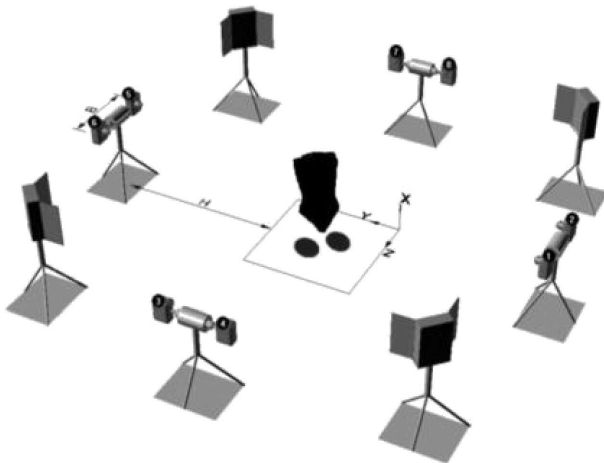

Fig. 7. Layout of the body scanning system [15].

Analysis of the scan results depending on the patient position is described by Reece et al. [16]. The results of the research have been used for surgical planning in the breast surgery.

The review of several techniques for 3D reconstruction of facial structure for craniofacial and aesthetic surgery has been presented by Kumar and Vijai [17].

Brownridge and Twigg [18] used infrared sensing technology to produce a representative avatar of a scanned object. This could be used to contribute to a virtual fashion show or for motion analysis purposes.

The cost-effective scanning system, which is based on two Microsoft Kinect sensors, has been presented by Chen et al. [19]. The scan results have been used for designing personalized details of hairstyle and face.

The application of 3D scanners for the human body measurement is noticeable in scientific literature.

Smulders et al. [20] used 3D scanner for acquiring the human body shape. The measurement results were used for designing of the more comfortable, lighter and optimised space aircraft seat.

Application of the 3D scanning technique in clothing industry is described by Li [21].

The review of 3D scanners for acquiring the human body gave a chance for constructing new scanner, which is used for the human body parts scanning.

Surround 3D scanner [22]

The surround 3D scanner is shown in Fig. 8.

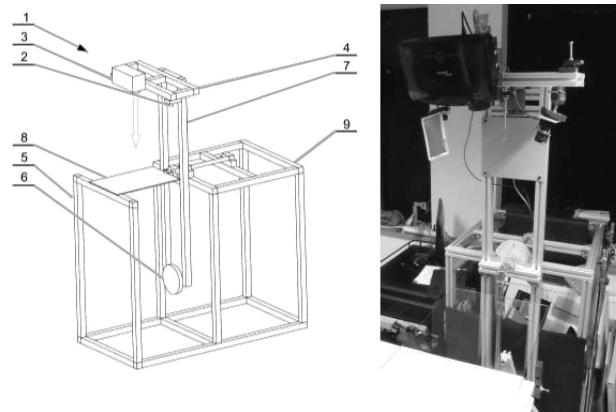

Fig. 8. Surround 3D scanner [22].

Two 1.3 MPix cameras (1,2) and stripe projector (3) are mounted on the base frame (4), which is rotated around the axis of revolution (5) (Fig. 8). The counterbalance (6) stabilizes the rotational frame (7). The glass plate (8) on the scanner body (9) is used for placing the scanned object (Fig. 8).

The scanner optics is controlled by FlexScan3D software. The scans are combined by markers or by geometry fitting.

The presented scanner is used for medical application, mostly for the human hands scanning (Fig. 9).



Fig. 9. Result of scanning.

Scanner accuracy

Described surround 3-dimensional scanner uses glass table for placing scanned object. This fact implicates scanning through the glass plate, when the scanner's head is located below the table. The question is what the impact of the glass plate on the scanner's accuracy is.

This chapter compares the scanner's accuracy when its head is located above (scanning without

glass) and below table (scanning through the glass plate).

Verification procedure of the scanner's accuracy has been carried out according to recommendations of the German PTB with VDI/VDE 2634 standard, part 2 "Optical 3D measuring systems – Optical systems based on area scanning" [23, 24].

Two types of test have been conducted (Fig. 10):

- a) probing error,
- b) sphere-spacing error.



Fig. 10. Standards for acceptance tests for: a) probing error, b) sphere-spacing error [23].

The quality parameter for probing error works on a small part of the measurement volume to record the range of residuals for a best fit sphere.

The quality parameter for sphere spacing tests the system capability for measuring 3D length. The sphere spacing quality parameter is then tested by measuring the ball bar in seven recommend positions within the systems' field of view, with the intent of covering the entire measurement volume (Fig. 11).

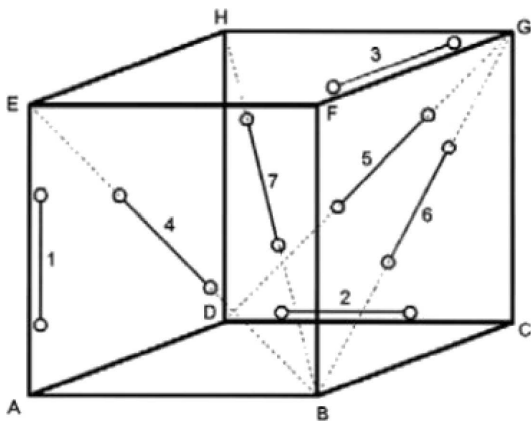

Fig. 11. Sphere-spacing test [24].

The standards have been scanned without and through the glass plate. The results of scanning – clouds of points – have been sent to Digitized Shape Editor of Catia V5 system. Then the spheres have been fitted to the clouds of points, using least-squares method. Finally, the sphere diameter and distance between spheres have been calculated (Fig. 12).

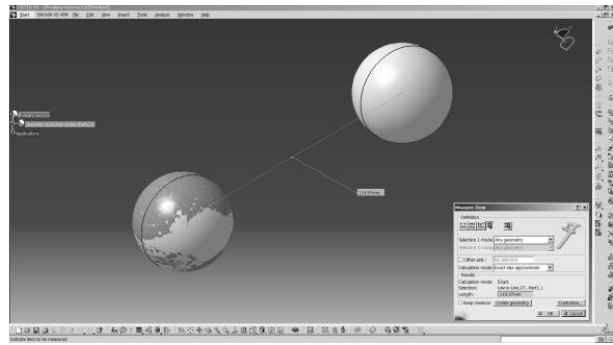

Fig. 12. Fitted sphere and sphere-spacing measurement.

The results of tests are shown in Tables 1–4.

Table 1
 Probing error – scanning without the glass plate (tested sphere diameter $D_s = 44.629$ mm).

No. of measurement	Measured diameter D [mm]	Probing error $D_s - D$ [mm]	Probing error [%]
1	44.988	-0.359	-0.80
2	44.963	-0.334	-0.75
3	44.969	-0.340	-0.76
4	44.953	-0.324	-0.73
5	44.986	-0.357	-0.80
6	45.005	-0.376	-0.84
7	44.961	-0.332	-0.74
8	44.979	-0.350	-0.78
9	44.959	-0.330	-0.74
10	44.972	-0.343	-0.77
11	44.987	-0.358	-0.80
12	44.959	-0.330	-0.74

Table 2
 Probing error – scanning through the glass plate (tested sphere diameter $D_s = 44.629$ mm).

No. of measurement	Measured diameter D [mm]	Probing error $D_s - D$ [mm]	Probing error [%]
1	44.933	-0.304	-0.68
2	44.897	-0.268	-0.60
3	44.939	-0.310	-0.69
4	44.935	-0.306	-0.69
5	44.976	-0.347	-0.78
6	44.953	-0.324	-0.73
7	44.911	-0.282	-0.63
8	44.937	-0.308	-0.69
9	44.962	-0.333	-0.75
10	44.962	-0.333	-0.75
11	44.949	-0.320	-0.72
12	44.965	-0.336	-0.75

Table 3
 Sphere-spacing error – scanning without the glass plate
 (tested sphere-spacing distance $L_s = 120.093$ mm).

No. of measurement	Measured diameter L [mm]	Sphere-spacing error $L_s - L$ [mm]	Sphere-spacing error [%]
1	120.047	0.046	0.04
2	120.068	0.025	0.02
3	120.003	0.090	0.07
4	120.023	0.070	0.06
5	120.037	0.056	0.05
6	120.026	0.067	0.06
7	120.010	0.083	0.07

Table 4
 Sphere-spacing error – scanning through the glass plate
 (tested sphere-spacing distance $L_s = 120.093$ mm).

No. of measurement	Measured diameter L [mm]	Sphere-spacing error $L_s - L$ [mm]	Sphere-spacing error [%]
1	120.148	-0.055	-0.05
2	120.118	-0.025	-0.02
3	120.121	-0.028	-0.02
4	120.143	-0.050	-0.04
5	120.144	-0.051	-0.04
6	120.182	-0.089	-0.07
7	120.166	-0.073	-0.06

One can see that sphere-spacing error for scanning through the glass plate is generally negative contrary to positive error for scanning without glass plate. It can be explained by law of refraction [25, 26] (Fig. 13). The projected ray defines the cutting plane. The reflected ray is acquired by camera. The scanner software calculates the reflection point by projection of acquired point on the cutting plane. The glass plate causes refraction. In this case the cutting plane is moved in relation to projected ray, but the scanner software projects the acquired point on the plane, which is defined by projected ray before refraction.

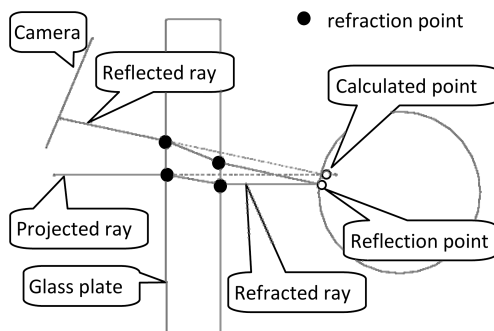

Fig. 13. Beam shift due glass plate.

Conclusions

The described surround 3-dimensional structured light scanner has been designed for scanning of parts of patient's body, primarily hands and forearms. The glass table gives a possibility of stabile placing of a hand therefore it prevents patient's instinctive movements.

The average probing error for scanning through the glass plate is -0.314 mm and it is similar to error without glass table (-0.344 mm). The relative percentage errors for both mentioned above are less than 1%.

The influence of light ray refraction is exposed in sphere-spacing errors analysis, but the absolute average errors are less than 0.1 mm and relative percentage errors are less than 0.1%. They are accepted values for the human body scanner.

The surround 3D scanner is used for scanning patients. The results of scanning are the basis for designing the compression garments for treatment of burn and scald scars [27]. This garments give better therapeutic effects than products measured by hand, because the compression effect depends on the quality of human body representation.

References

- [1] Górski F. et al., *Application of close-range photogrammetry in reverse engineering*, Proceedings of the 7th International Conference of DAAAM Baltic Industrial Engineering, 1–2, 30–35, 2010.
- [2] Razak T. et al., *Application of 3D Scanning onto Automotive Door Panel for Quality*, International Conference on Robotics and Automation Engineering, p. 31–34, 2016.
- [3] Górski F. et al., *Effective Design of Educational Virtual Reality Applications for Medicine using Knowledge-Engineering Techniques*, Eurasia Journal of Mathematics Science and Technology Education, 13, 2, 395–416, 2017.
- [4] Chang C.C. et al., *Error control and calibration in three-dimensional anthropometric measurement of the hand by laser scanning with glass support*, Measurement, 40, 1, 21–27, 2007.
- [5] Tong J., Zhou J., Liu L., Pan Z., Yan H., *Scanning 3D Full Human Bodies using Kinects*, Visualization and Computer Graphics, 18, 4, 643–650, 2012.
- [6] shenghuijingmi.en.made-in-china.com/.
- [7] www.artec3d.com/cases/eva-helps-produce-3d-printed-prosthesis-gastrocnemius-muscle.

- [8] Massen R., *Arrangement and method for producing photogrammetric image records*, United States Patent No. US 7095886 B2, 2006.
- [9] Kahlon S., *Apparatus for recommendation for best fitting shoe*, United States Patent No. US 20140285646 A1, 2014.
- [10] Huang J-T., Yu F., *Apparatus and method for rapidly measuring 3-dimensional foot sizes from multi-images*, United States Patent No. US 7742633 B2, 2010.
- [11] Tohme Y., *System and method of acquiring three-dimensional coordinates using multiple coordinate measurement devices*, United States Patent No. US 20140028805 A1, 2014.
- [12] Rodríguez-Quinónez J.C. et al., *Optical monitoring of scoliosis by 3D medical laser scanner*, *Optics and Lasers in Engineering*, 54, 175–186, 2014.
- [13] <http://vorum.com/cad-cam-prosthetic-orthotic/scangogh-3d-scanner/>.
- [14] Liu Z. et al., *3D real human reconstruction via multiple low-cost depth cameras*, *Signal Processing*, 112, 162–179, 2015.
- [15] Pesce M., Galantucci L.M., Percoco G., Lavecchia F., *A low-cost multi camera 3D scanning system for quality measurement of non-static subjects*, *Procedia CIRP*, 28, 88–93, 2015.
- [16] Reece G.P. et al., *3D surface imaging of the human female torso in upright to supine positions*, *Medical Engineering and Physics*, 37, 375–383, 2015.
- [17] Kumar S.T., Vijai A., *3D Reconstruction of Face from 2D CT Scan Images*, *Procedia Engineering*, 30, 970–977, 2012.
- [18] Brownridge A., Twigg P., *Body scanning for avatar production and animation*, *International Journal of Fashion Design, Technology and Education*, 7, 2, 125–132, 2014.
- [19] Chen Y., Dang G., Cheng Z.-Q., Xu K., *Fast capture of personalized avatar using two Kinects*, *Journal of Manufacturing Systems*, 33, 1, 233–240, 2014.
- [20] Smulders M. et al., *Comfort and pressure distribution in a human contour shaped aircraft seat (developed with 3D scans of the human body)*, *Work*, 54, 4, 925–940, 2016.
- [21] Li X., Li X., *Human body dimensions extraction from 3D scan data*, 2010 International Conference on Intelligent Computation Technology and Automation, 2, 441–444, 2010.
- [22] Karbowski K., *Skaner białego światła strukturalnego*, W.124119, Biuletyn Urzędu Patentowego, Urząd Patentowy Rzeczypospolitej Polskiej, Warszawa 25/2016, p.49.
- [23] Ostrowska K., Szewczyk D., Śladek J., *Calibration of optical systems according to ISO standards and VDI/VDE recommendations*, *Technical Transactions*, 9-M/2012, 167–179, 2012
- [24] Pfeffer C., *The state of 3-D imaging standards*, *Quality Digest*, 11/09/2010.
- [25] physics.info/refraction/.
- [26] Li Z., Chang C.-C., Dempsey P.G., Cai X., *Refraction effect analysis of using a hand-held laser scanner with glass support for 3D anthropometric measurement of the hand: A theoretical study*, *Measurement*, 41, 842–850, 2008.
- [27] Karbowski K., Sujka W., *Reverse engineering in medicine*, *Mechanik*, 88, 12, 111–113, 2015.