

RATIONAL DISTRIBUTION OF EXCESS REGENERATIVE ENERGY IN ELECTRIC TRANSPORT SYSTEMS ON THE BASIS OF FUZZY LOGIC APPLICATION

Oleg Sablin¹, Valeriy Kuznetsov², Victor Shinkarenko³, Alexander Ivanov⁴

^{1,2,3,4} Dnepropetrovsk National University of Railway Transport named after Academician V. Lazaryan, Dnipro, Ukraine

¹e-mail: olegsss@i.ua

²e-mail: vkuz@i.ua

³e-mail: shinkarenko_vi@ua.fm

⁴e-mail: iv_@inbox.ru

Abstract: *Purpose.* To develop the fuzzy model of distribution of excess regenerative energy in traction and external power supply systems allowing to exercise effective operation of the power equipment. *Relevance.* For effective distribution of excess regenerative energy in systems of electric transport, as well as for systems equipped with stationary stores of energy and inverting traction substations with regulators of output voltage it is necessary to solve a number of the problems with high degree of uncertainty demanding taking into account a set of random factors such as the modes of power lines and traction loadings. These factors have to be considered in operation for choosing the rational modes of energy stores, inverters and regulators of voltage on buses of substations to provide the rational conditions for energy regeneration on electric transport. *Scientific novelty.* The control system of energy storage devices, inverters and traction substation output voltage regulators, designed on the basis of fuzzy logic, can provide the necessary conditions for the regeneration on electric transport on sections with a shortage of traction power consumption and allows to optimize the distribution of excess braking energy of transport vehicles. It is achieved by determining the rational relationship between the components of the excess current of regeneration in real time, which can ensure a minimum of power losses of regenerative energy in traction and external power supply systems. *Practical importance.* The use of the developed approach is effective under the conditions of incomplete information received by measurement systems and on the basis of additional studies it can allow to minimize rated capacity of stores, inverters and traction substation output voltage regulators that could reduce the costs of modernization of existing sections and electrification of new electric transport systems.

Key words: *regeneration of the electric power, stores, inverters, regulation of voltage, traction, external power supply, fuzzy logic.*

1. Introduction

The perspective pillar of development of nonautonomous electric transport systems is transition to the distributed traction power supply, introduction of the energy store device (SD) and intellectual train dispatching systems allowing to solve successfully power and environmental problems on transport. Meanwhile, one of the most effective method of energy saving on electric transport still remain the effective use of regenerative energy, which in the case of the rational modes of the vehicles' movement allows to reduce the power consumption for transportation process in different modes of movement by 15...30% (Shevlyugin, 2007; Sulim et al., 2012).

However, owing to specifics of traction power consumption modes the average value of regenerated energy, for example in systems of the main transport, does not exceed currently 2...3% (Shcherbak and Nerubackiy, 2011; Sergienko, 2010; Sopov, 2012). It is mainly related with a time spread of processes of energy consumption and energy generation by the vehicles which are on a section in the traction and regenerative modes that is especially noticeable in the case of small traffic. Energy quality during regeneration on the buses of substations must also be taken into account (Sychenko et al., 2015). Complex application of the mentioned technologies can improve regenerative modes of the electric power on non autonomous electric transport.

2. Review of literature and problem statement

For providing the regenerative mode of energy the voltage on a pantograph of the regenerating train has to exceed the voltage on a contact line (Getman, 2011) and not exceed the maximal admissible value (GOST 6962-75, 1975; EN 50163, 1996; Red, Pawlik, 2015). Very frequently (especially in the case of small traffic) there is a problem of consumption of the regenerated energy. Under the conditions of decreased traction power consumption or lack of it on a regenerative zone the voltage on pantograph of the regenerating trains reaches the maximal admissible value U_{max} (fig.1) and return of energy to a traction line becomes impossible.

Fig. 2 shows the realizations of voltage and current of a suburban electric DC train EPL2T on some section. Here it is possible to observe frequent unsuccessful acts of regenerative braking of the train, which termination is caused by achievement of voltage on a pantograph the maximal admissible value (4,0 kV) owing to absence in a regenerative zone of trains in the traction mode. In addition, the effectiveness of the modes of regeneration depends on the voltage level at the busbars of traction substations (Sychenko et al., 2015).

In this case the energy saving effect from regeneration decreases as the generated energy is utilized by brake mechanisms of the vehicle.

The solution of problem of consumption of excess regenerative energy can be carried out in several directions (Shchurov, 2002):

- 1) transmission of energy from a traction line to external power supply system;
 - 2) optimization of train schedules;
 - 3) using of energy store devices;
- expansion of a regenerative zone by regulation (decreasing) of voltage on buses of the traction substations (TS).

At stopping braking of vehicles takes place a short-term energy generation, which can be characterized by the indicators given in (Sablin, 2014).

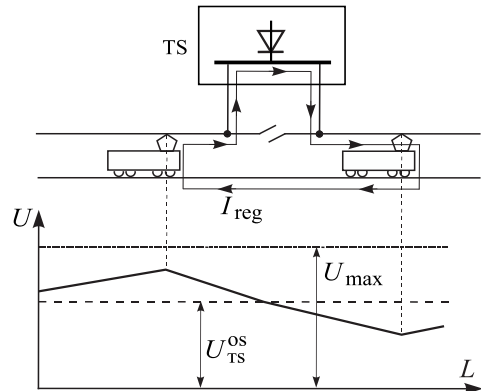

Fig. 1. Distribution of voltage along a contact line during regeneration of the electric power

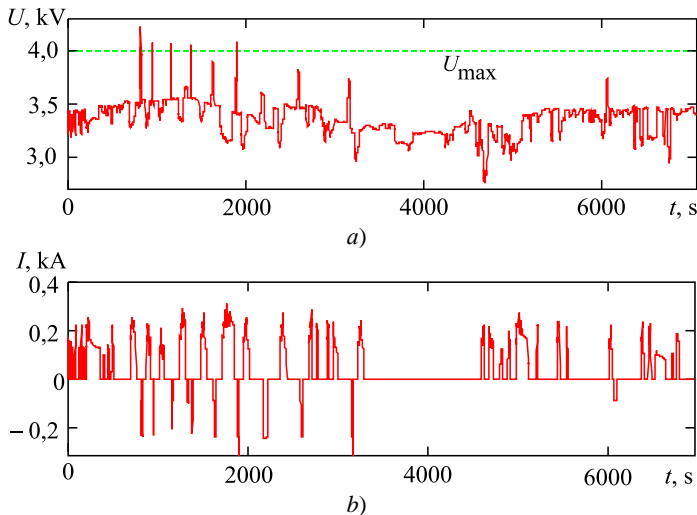

Fig. 2. Time diagram of voltage on a pantograph (a) and traction current (b) of DC electric train EPL2T

Considering the fact that transmission of braking energy of trains from a traction line through the traction substations (TS) to the external power supply system (on DC section – through the inverting TS) is possible under a condition when its reception by a line is coordinated both in technical, and commercial aspects, such as (Shchurov, 2002):

- the maximal admissible short-term power accepted by a line;
- the acceptable level of harmonics;
- readiness of the power supplying company for refinancing.

The measurements made on mountain section with inverting DC TS (Sablin et al., 2016) show that efficiency of consumption of excess regenerative energy by external power supply system (on 35, 110, 220 kV) depends of the modes of not traction loadings in knots of TS connection, especially during the periods when the power supply system is underloaded. Lack of necessary value of not traction loadings in a power line increases the voltage on TS inputs in the regenerative mode and leads to the termination of energy transmission from a traction line, and to the termination of the regeneration on a rolling stock on a condition of the maximal admissible voltage on pantograph.

Besides, it is experimentally established that in the case of connection of adjacent inverting TS to lines at different voltage regeneration of energy near one TS (connected to 35 kV) cannot lead to its transition to the inverter mode, and transfer of excess braking energy of the train occurs through the remote TS (connected to 110 kV). In this case there is unequal distribution of loading of the inverting TS in the recovery mode that leads to increased regeneration energy losses in traction line.

Thus, for realization of effective distribution of regeneration energy in systems of electric transport (as well as in the perspective power supply system equipped with energy store devices, reversible TS with smooth regulation of output voltage) it is necessary to solve a number of the problems with high degree of uncertainty demanding the accounting of a set of random factors such as the modes of power lines and traction loadings. These factors have to be considered in dispatching of energy store devices modes, inverters and voltage regulators on TS buses allowing to provide rational conditions of energy regeneration.

3. Purpose and research task

The purpose of this article is creation of indistinct model of regeneration energy distribution in traction systems and in external power supply system on electric transport, taking into account the prospects of using on TS inverters, energy stores and regulators of output voltage.

For rational distribution of regenerative energy in this article the problem of dispatching of the modes of energy store devices, inverters and regulators of output voltage on TS is solved on the basis of fuzzy-logic.

4. Formulation of the problem of rational distribution of excess regenerative energy

For providing rational conditions for regeneration on electric transport in traction power supply system equipped with stationary operated energy store device (SD) and reversible TS with smooth regulation of the output voltage (fig. 3) it is necessary to solve a number of problems with high degree of uncertainty. It involves taking into account many random factors, such as the modes of power lines and traction loadings, which directly influence to optimum algorithms of dispatching of SD, inverters and regulators of output voltage on TS.

The scheme of regeneration current decomposition on electric transport I_{reg} is given at fig. 3, where excess current is shown as a part of I_{reg} , which cannot be directly consumed on traction by passing (opposite) trains that are in a recovery zone, i.e.

$$I_{reg}^{ex} = I_{reg} - I_{reg1} = \sum_{k=2}^5 I_{regk}, \quad (1)$$

where:

- I_{reg1} – the part of current of regeneration consumed on traction by passing (opposite) trains;
- I_{reg2} – the part of current of regeneration utilized in brake rheostats;
- I_{reg3} – the part of current of regeneration, which can be transmitted to adjacent zones to remote trains by regulation of voltage on transit TS buses;
- I_{reg4} – the part of current of regeneration, which is consumed by SD;
- I_{reg5} – the part of current of regeneration transmitted to the external power supply system (via TS inverters).

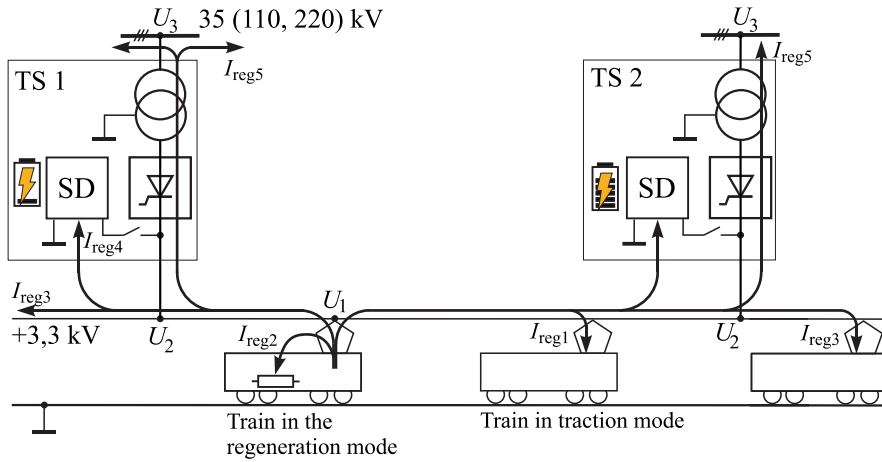

Fig. 3. Distribution of current of regeneration in traction and external power supply system

For reduction of regenerative energy losses ΔP_{reg} in elements of traction and external power supply system it is necessary to provide the minimum possible distance to the potential consumers (the trains, SD, external power system) taking into account their efficiency. The problem of rational distribution of excess regenerative energy of trains can be defined as finding out the ratio between values of current' components (1) in real time that minimize the criterion function

$$\left(\begin{array}{l} I_{reg2}(t) \rightarrow \min, \\ \Delta P_{reg}(I_{reg3}(t), I_{reg4}(t), I_{reg5}(t)) \rightarrow \min \end{array} \right), \quad (2)$$

taking into account the restraint on vehicle pantograph voltage in the mode of regeneration (Rutkovskaya, 2006; Piegat, 2001)

$$U_1(I_{reg3}(t), I_{reg4}(t), I_{reg5}(t)) \leq U_{1max} \quad (\text{fig. 1, 3}).$$

The requirements of modeling accuracy demand to take into account many factors defining rational distribution of regenerative energy of train, development of difficult mathematical models and measurement methods, which realization demands big expenses. The experts assessment can serve as a basis for decision-making process (Passino, 1998; Wang, 1997).

Considering the low level of support information in traction power supply systems, for decision-making according to (2) the principles of fuzzy dispatching can be used. Fuzzy regulation laws of the modes of traction power supply system provide maintenance of voltage on pantograph of the regenerating trains in admissible limits under the condition of insufficient traction power consumption in a regeneration zone. It is realized by making decisions about the level of regenerative energy that could be consumed by store devices (depending on their charge), returned to the external power supply system (depending on its loading), and transferred to the adjacent zones between TS to the remote trains (depending on their situation on a section). Thus, coordination of operation of energy store devices in the alignment modes for peak traction loadings and local buffering of excess regenerative energy is possible.

At a ratio of regenerative currents and traction ones on a regeneration zone

$$\frac{I_{trac}(t)}{I_{reg}(t)} \geq 1$$

excess current $I_{reg}^{exc} = 0$ and the system needn't any regulations. Otherwise, it's necessary to regulate the modes of the power equipment for optimization of current I_{reg}^{exc} distribution under the criterion (2).

5. Fuzzy model of dispatching of excess regenerative energy distribution

Priority of transmitting of excess regenerative energy to SD, external power supply system or to trains on remote section (respectively currents I_{reg3} , I_{reg4} or I_{reg5}) is defined depending on the location of the regenerating train on a section in relation with potential energy receivers and their state. Fuzzy regulation of operating modes of SD, inverters and regulators of output voltage on TS has to take into account the admissible values (2) and voltage constraint in traction line according to (GOST 6962-75, 1975; EN 50163, 1996) in cases when $U_1 \rightarrow U_{1max}$.

Input data of fuzzy model of regulation (according to fig. 3) is the set of variables

$$X = \langle E(t), I_1(t), U_1(t), U_2(t), U_3(t) \rangle,$$

where:

$E(t)$ – current charge degree SD;

$I_1(t)$ – a traction consumption in a zone of regeneration;

$U_1(t)$ – voltage on a pantograph of the regenerating train;

$U_2(t)$ – voltage on the TS feeder;

$U_3(t)$ – voltage of the external power supply system (on TS input).

The regulation parameters of the fuzzy regulator are variables:

$$Y = \langle I_{reg2}(t), I_{reg3}(t), I_{reg4}(t), I_{reg5}(t) \rangle,$$

which represents the components of excess regenerative current that should be defined according to a condition (2).

Input and output variables have the ranges of definition, which are broken into three or four fuzzy ranges (terms) specified in tab. 1 and tab.2 where low – low level, medium low – average low, medium – average, medium high – average high, high – high level.

Input and output variables are set by fuzzy terms with triangular accessory functions (Leonenkov, 2005). For example, the accessory functions respectively for the input variable $I_1(t)$ and output one $I_{reg4}(t)$ are given at fig. 4. The linear form of accessory functions and its parameters are chosen according to the expert opinion. However, other form of accessory function can be chosen (for example, exponential) on the basis of comparison of the solution of this task by determined and fuzzy methods. The proximity of the received results will correspond to the more adequate accessory function. The mentioned accessory functions can be presented as tab. 3 and 4.

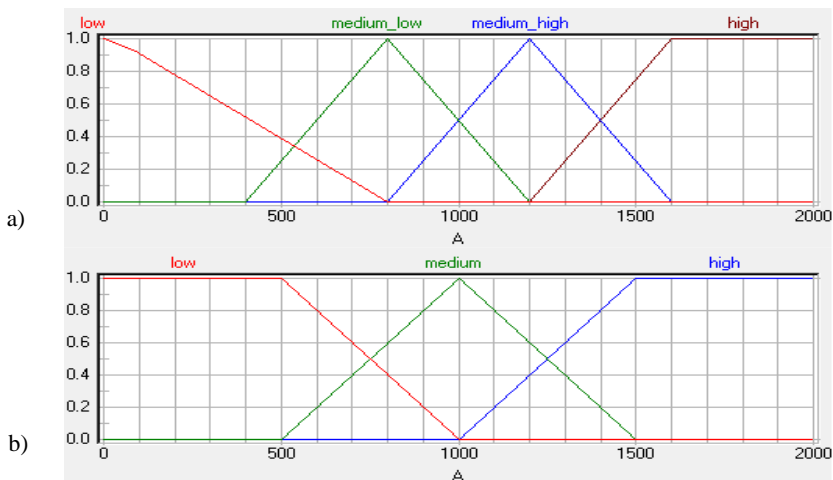

Fig. 4. Accessory functions for input parameter – traction loading in a regeneration zone (a) and output parameter – a part of regenerative current consumed by brake rheostats (b)

Table 1. Input data and their ranges

No	Variable' name	Range	Terms
1	$E(t)$	0...100 %	low medium high
2	$I_1(t)$	0...2 kA	low medium low medium high high
3	$U_1(t)$	2,2...4 kV	low medium low medium high high
4	$U_2(t)$	2,7...4 kV	low medium high
5	$U_3(t)$	33...37 kV	low medium high

Table 2. Parameters of regulation and their ranges

No	Variable' name	Range	Terms
1	$I_{reg2}(t)$	0...2 kA	low medium high
2	$I_{reg3}(t)$	0...2 kA	low medium high
3	$I_{reg4}(t)$	0...2 kA	low medium high
4	$I_{reg5}(t)$	0...2 kA	low medium high

Table 3. Accessory function for traction load on a regeneration zone

Name of a term	Function	Values (x, y)		
low	linear	(0, 1)	(82, 0,9)	(800, 0)
		(2000, 0)		
medium low	linear	(0, 0)	(400, 0)	(800, 1)
		(1200, 0)	(2000, 0)	
medium high	linear	(0, 0)	(800, 0)	(1200, 1)
		(1600, 0)	(2000, 0)	
high	linear	(0, 0)	(1200, 0)	(1600, 1)
		(2000, 1)		

Table 4. Accessory function of the part of the regenerative current consumed in brake rheostats

Name of a term	Function	Values (x, y)		
low	linear	(0, 1)	(500, 1)	(1000, 0)
		(2000, 0)		
medium	linear	(0, 0)	(500, 0)	(1000, 1)
		(1500, 0)	(2000, 0)	
high	linear	(0, 0)	(1000, 0)	(1500, 1)
		(2000, 1)		

The model of rational distribution of excess regenerative energy is developed on the basis of five blocks of rules, which structure is given in fig. 5. Each block of rules uses Mamdani's method for an fuzzy conclusions (Piegat, 2001). Blocks are connected in the form of sequence for ensuring step-by-step decision-making, on the set priorities.

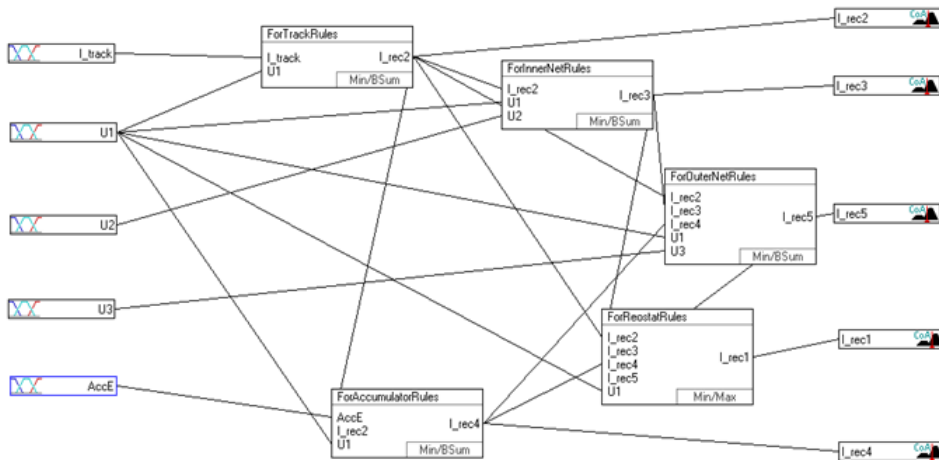

Fig. 5. Structure of the model of regenerative energy distribution

The output of the first block serves as an input for the following one that allows to determine the need of distribution of the rest of energy according the directions with less priority. The inputs for the last block of a output are all previous decisions that allow to define a conclusion only if the decision was not made yet.

If there is deficiency or lack of a traction power consumption a on a section of regeneration ($U_1 \rightarrow U_{1max}$, fig. 3), it is necessary to make a number of commutation of the power equipment on TS for providing the required conditions for regeneration. Rules for making decisions about distribution of current I_{reg}^{exc} , elaborated by the expert, represent a sequence of steps on regulation of the power equipment on TS.

Rule 1. To switch SD in a charge mode:

$$\begin{cases} I_{reg4} \rightarrow I_{reg}, (I_{reg3} + I_{reg5}) \rightarrow \min, \text{ when } E(t) = 0 \% ; \\ I_{reg4} \rightarrow \text{opt}, (I_{reg3} + I_{reg5}) \rightarrow \text{opt}, \text{ when } E(t) < 100\% ; \\ I_{reg4} = 0, (I_{reg3} + I_{reg5}) \rightarrow I_{rec}, \text{ when } E(t) = 100\% . \end{cases}$$

Rule 2. To decrease the voltage $U_2(t)$ on output TS buses in the range $U_2(t) \geq U_{2min}$ for providing

$$\begin{cases} U_1(t) < U_{1max} : \\ I_{reg3} \rightarrow I_{reg}, I_{reg5} \rightarrow \min, \text{ if } U_1(t) < U_{1max} \\ \text{when } U_2(t) \geq U_{2min} ; \\ I_{reg3} \rightarrow 0, I_{reg5} \rightarrow I_{reg}, \text{ if } U_1(t) = U_{1max} \\ \text{when } U_2(t) = U_{2min} . \end{cases}$$

Rule 3. To switch on TS to the inverting mode (if voltage of a power line $U_3(t) < U_{3max}$).

$$\begin{cases} I_{reg5} \rightarrow I_{reg}, \text{ when } U_3(t) < U_{3max} ; \\ I_{reg5} \rightarrow 0, I_{reg} = I_{reg2}, \text{ when } U_3(t) \geq U_{3max} . \end{cases}$$

Rule 4. To switch on the rheostat braking (if $E(t) = 100\%$, $U_2 = U_{2min}$, $U_3(t) = U_{3max}$).

The last rule represents a partial use of excess regenerative energy with current $I_{reg2}(t)$ is the most undesirable option, therefore it is applied when there

are any opportunities of energy distribution by currents $I_{reg3}(t)$, $I_{reg4}(t)$, $I_{reg5}(t)$ according to the rules 1-3.

The provided heuristic rules are structured by means of model on fig. 5 in the environment of «FuzzyTech» (Leonenkov, 2005) in the form of the blocks presented in tab. 5.

Table 5. Structure of blocks of fuzzy model

No	Block name	Description	Inputs	n*
1	ForTrackRules	Determination of the energy transferred to traction need	U_1, I_1	16
2	ForAccumulatorRules	Determination of energy for transferring to the store devices	U_1, E, I_{reg2}	32
3	ForInnerNetRules	Determination of energy for transferring to TS	U_1, U_2, I_{reg2}	12
4	ForOuterNetRules	Determination of energy for transferring to an external power supply system	$U_1, U_3, I_{reg2}, I_{reg3}, I_{reg4}$	120
5	ForReostatRules	Determination of the energy utilized in brake rheostats	$U_1, I_{reg2}, I_{reg3}, I_{reg5}$	63
n* – number of rules				

Blocks contain the rules set in the form of tables. For example, the block of the rules «ForAccumulatorRules» – determination of the energy transmitted to the store devices. Each block contains the large number of lines describing a set of conditions for entrances and exits. DoS indicator (Leonenkov, 2005) designates degree of reliability of each rule (tab. 6).

Table 6. Indicators of the degree of reliability of rules

IF			THEN	
E	I_{reg2}	U_1	DoS	I_{reg4}
low	low	low	1,00	high
low	low	medium low	1,00	high
low	low	medium high	1,00	high
low	low	high	1,00	high
low	medium	low	1,00	medium
....
high	high	high	1,00	low

6. Realization of fuzzy distribution of the excess regenerative energy

For making decision about the amount of regenerative energy to be transferred, for example, to the store for temporary storage, as input parameters are variables $U_1(t)$ and $E(t)$, and exit $I_{reg4}(t)$. Knowledges of the expert are represented as a ratio:

$$R = (U_1, E) \rightarrow I_{reg4},$$

where:

(U_1, E) – assumption;

I_{reg4} – a consequence;

\rightarrow – operation of fuzzy implication.

For each parameter are known the fuzzy terms accessory functions, according to $\mu_{U_1, i}(x)$, $\mu_{E, i}(x)$ and $\mu_{I_{reg4}, i}(x)$. Degree of accessory for given entrance

values (U_1, E) to each rule from expert base is defined by expression:

$$\mu_{I_{reg4}, j}(I_{reg4}) = \mu_{E, j}(U_1) \wedge \mu_{I_{reg4}, j}(E),$$

where

$j = 1.$

n – number of the rule;

\wedge – operation of a logical minimum.

As a result we receive the following fuzzy set

$$I_{reg4} = \bigvee_{j=1..n} \mu_{I_{reg4}, j}(I_{reg4}),$$

where: \bigvee – operation of a logical maximum.

The exact (accurate) value of parameters of a variable I_{reg4} is defined as the average sum

$$I_{reg4} = \frac{\sum_{j=1..n} \mu_{I_{reg4}, j}(I_{reg4}, j) I_{reg4}, j}{\sum_{j=1..n} \mu_{I_{reg4}, j}(I_{reg4}, j)}.$$

For determination of accurate values of output variables in work the method «Center of Area» of a defazifikation was used. As a result of search of a set of options of various entrance conditions of model according to (Piegat, 2001) are received the spaces of making decisions on distribution of regenerative energy on electric transport in all possible directions. The geometrical interpretation in certain conditions of these decision making spaces are the surfaces presented on fig. 6.

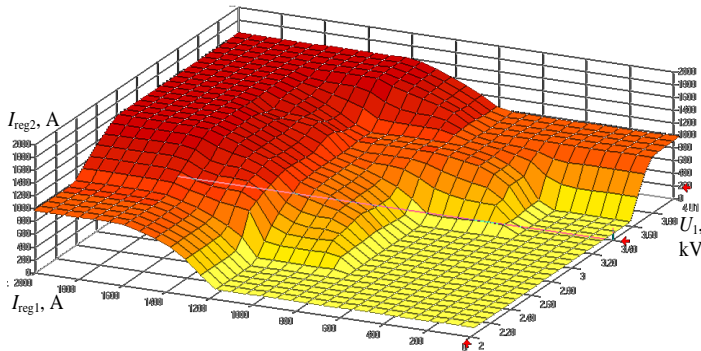

Fig. 6a. Decision-making area for equations $I_{reg2} = f(I_{reg1}, U_1)$

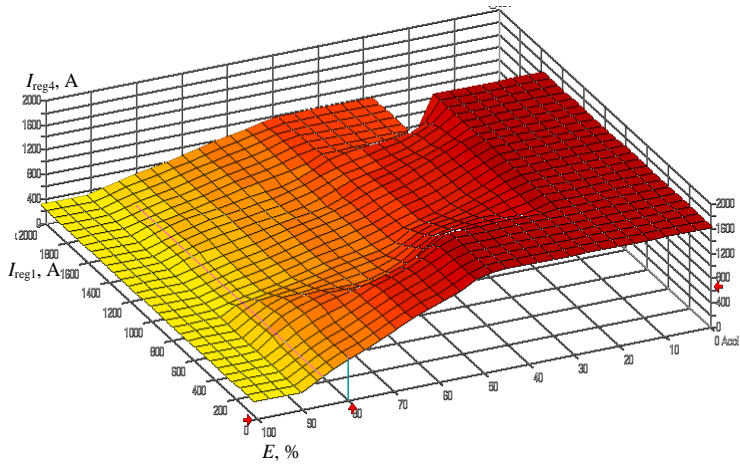

Fig. 6b. Decision-making area for equations $I_{reg4} = f(I_{reg1}, E)$

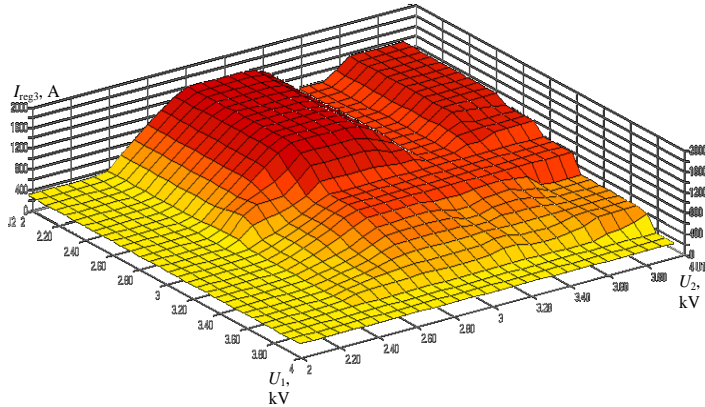

Fig. 6c. Decision-making area for equations $I_{reg3} = f(U_1, U_2)$

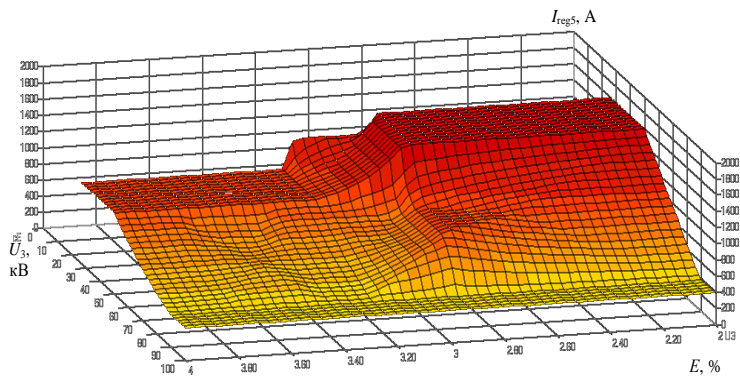

Fig. 6d. Decision-making area for equations $I_{reg5} = f(E, U_3)$

These equations show necessary algorithms of power equipment management on TS in real time depending of current state of the traction and external power supply systems (the traction loadings in a zone of regeneration and a charge of stores, voltage on TS).

The fig. 7 shows the examples of the decision made by «FuzzyTech» program for a given case of decision-making about distribution of excess regenerative energy in traction and external power supply system of electric transport.

The system of fuzzy management will allow to make quick decisions about rational distribution of excess regenerative energy based on the incomplete data obtained by measuring systems. These decisions are a basis of intellectual regulation of the modes of traction power supply system during the regeneration of rolling stock.

Inputs:		Outputs:	
AccE	80.0000	_rec1	1439.7500
I_track	0.0000	_rec2	187.6500
U1	3.3000	_rec3	741.3000
U2	3.4000	_rec4	777.9000
U3	4.0000	_rec5	633.3500

Inputs:		Outputs:	
AccE	19.0000	_rec1	(0.0000)
I_track	900.0000	_rec2	1000.0000
U1	3.5000	_rec3	(0.0000)
U2	2.0000	_rec4	1659.9500
U3	2.0000	_rec5	(0.0000)

Fig. 7. Examples of the output data obtained by modeling

7. Conclusions

The proposed control system can dispatch the energy store devices, inverters and regulators of output voltage on traction substations on the basis of fuzzy logic. This provides the necessary conditions of regeneration of electric transport on section with deficiency of a traction power consumption and allows to optimize the distribution of excess braking energy of vehicles. It is reached by determining of the rational ratio between components of excess regeneration current in real time that can provide a minimum of losses of regenerative energy in traction systems and external power supply systems.

The use of the developed approach is effective under the conditions of the incomplete information

received by measurement systems. On the basis of additional researches it is able to minimize the rated capacity of stores, inverters and regulators of output voltage of traction substations that will reduce capital cost for modernization of existing electrified sections and for electrification of new ones.

References

- [1] GETMAN, G., 2011. Theory of electric traction. Publishing house Makovetskiy, 456 p.
- [2] GOST 6962-75, 1976. The transport electrified from a contact line. Publisher of standards, 3 p.
- [3] EN 50163-1996, 1995. Supply voltage of traction railway lines. MCS 29.280, 11 p.
- [4] LEONENKOV, A., 2005. Fuzzy modeling in the environment of MathLab and FuzzyTech. SPb.: BHV-St, 736 p.
- [5] PASSINO, K., 1998. Fuzzy Control, Addison Wesley Longman. Menlo Park, 522 p.
- [6] PIEGAT, A., 2001. Fuzzy Modeling and Control. Physica-Verlag, Heidelberg, 256 p.
- [7] RED, S., PAWLIK, M., 2015. Compatibility of the railway system of the European Union. Infrastructure, control, energy, rolling stock. Publ.1, 241 p.
- [8] RUTKOVSKAYA, D., 2006. Neural networks, genetic algorithms and fuzzy systems. Hotline -Telecom, 452 p.
- [9] SABLIN, O., 2014. The study of the effectiveness of the regeneration process of electric power under the underground conditions. *East European journal of advanced technologies*, 6/8 (72), 9-13.
- [10] [SABLIN, O., BOSIY D., KUZNETSOV V., et al., 2016. The efficiency of regeneration of electric energy on electric transport system with DC inverter traction substations. *Bulletin of Vinnitsa Polytechnic Institute*, 2, 73-79.
- [11] SERGIENKO, N., 2010. Basic directions of work of Ukrzaliznica for energy conservation and the results. *Lokomotiv-inform*, 4, 24-26.
- [12] SOPOV, V., 2012. Ways of increasing the efficiency of electric braking energy use on rolling stock. *Online Electrician: Power industry. New technologies*.

- [13] SHEVLYUGIN, M., 2007. Decrease of the power consumption and working power of the main power equipment of traction substations of the electric railways by means of energy store devices. Monograph, 151 p.
- [14] SHCHERBAK, Y. and NERUBACKIY Y., 2011. Analysis of the use of the regenerative braking on the Ukrainian Railways. *Railway transport of Ukraine*, 2, 30-34.
- [15] SHCHUROV, N., 2002. Theoretical bases of transformation of regenerative energy during braking of the electric rolling stock. *Scientific Bulletin of the NSTU (Novosibirsk)*, 1(12), 121-129.
- [16] SULIM, A., 2012. Economy of the electric power using of the regenerative braking on subway cars. *Mater. inter. conf. Electromechanical and power systems, methods of modeling and optimization, KNU of M. Ostrogradsky*, pp. 344.
- [17] SYCHENKO V., BOSIY D., KOSAREV E., 2015. Improving the quality of voltage in the system of traction power supply of direct current. *Archives of transport*, 35(3), 63-70.
- [18] WANG L., 1997. *A Course in Fuzzy Systems and Control*. Prentice Hall, 424 p.